

WAAS CH <b>69220</b> <b>W13A</b>	APP CRS <b>133°</b>	Rwy Idg TDZE Apt Elev	<b>2623</b> <b>836</b> <b>836</b>
--	------------------------	-----------------------------	---

# RNAV (GPS) RWY 13

SMITH FLD (SMD)

RNP APCH.

Procedure NA at night. Rwy 13 helicopter visibility reduction below 1 SM NA.

For uncompensated Baro-VNAV systems, LNAV/VNAV NA below -16°C or above 54°C. When local altimeter setting not received, use Fort Wayne Intl altimeter setting: increase LPV DA to 1162 feet; LNAV/VNAV DA to 1435 feet; increase all MDA 40 feet and LNAV Cat C visibility ¼ SM. Baro-VNAV NA when using Fort Wayne Intl altimeter setting.

MISSED APPROACH: Climb to 2600 direct CUKEP and on track 043° to ZOBID and on track 313° to OHOCY and on track 280° to UDOMY and hold.

AWOS-3 <b>124.55</b>	FORT WAYNE APP CON <b>127.2 284.6</b>	UNICOM <b>122.8 (CTAF)</b>
-------------------------	--	-------------------------------

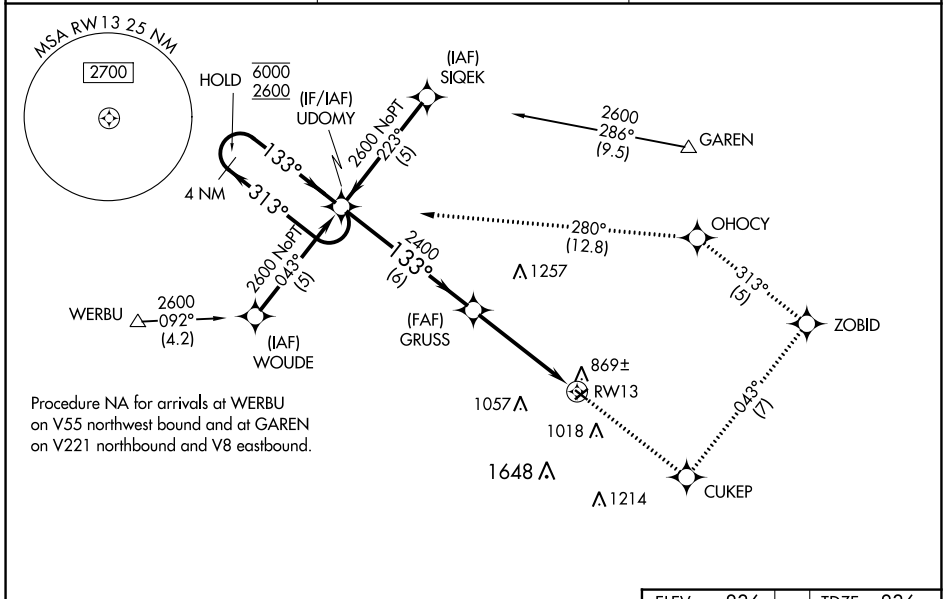

	2600	CUKEP	ZOBID	OHOCY	UDOMY
	↑	✧	✧	✧	✧
		tr 043°	tr 313°	tr 280°	
4 NM Holding Pattern	UDOMY				
6000 2600	← 313°	GRUSS 2400		RWY 13	
GP 3.00° TCH 40	→ 133°	2400			
	6 NM		4.7 NM		
CATEGORY	A	B	C	D	
LPV DA	1135-1		299 (300-1)		NA
LNAV/VNAV DA	1408-2		572 (600-2)		NA
LNAV MDA	1340-1	504 (600-1)		1340-1½ 504 (600-1½)	
CIRCLING	1400-1	564 (600-1)		1940-3 1104 (1200-3)	

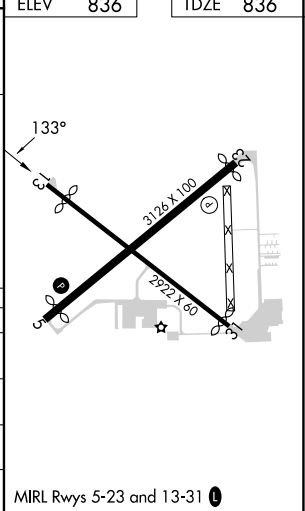

EC-2, 22 FEB 2024 to 21 MAR 2024

EC-2, 22 FEB 2024 to 21 MAR 2024

WAAS CH <b>65738</b> <b>W23A</b>	APP CRS <b>236°</b>	Rwy Idg TDZE <b>834</b> Apt Elev <b>836</b>	<b>3035</b> <b>834</b> <b>836</b>
--	------------------------	---	---

# RNAV (GPS) RWY 23

SMITH FLD (SMD)

RNP APCH.	<p>Procedure NA at night. Rwy 23 helicopter visibility reduction below 1 SM NA. When local altimeter setting not received, use Fort Wayne Intl altimeter setting and increase all MDA 40 feet and LP and LNAV Cat C visibility 1/8 SM.</p>	<p>MISSED APPROACH: Climb to 2700 direct JISUD and on track 294° to WERBU and hold.</p>
-----------	--	---

AWOS-3 <b>124.55</b>	FORT WAYNE APP CON <b>127.2 284.6</b>	UNICOM <b>122.8 (CTAF)</b>
-------------------------	--	-------------------------------

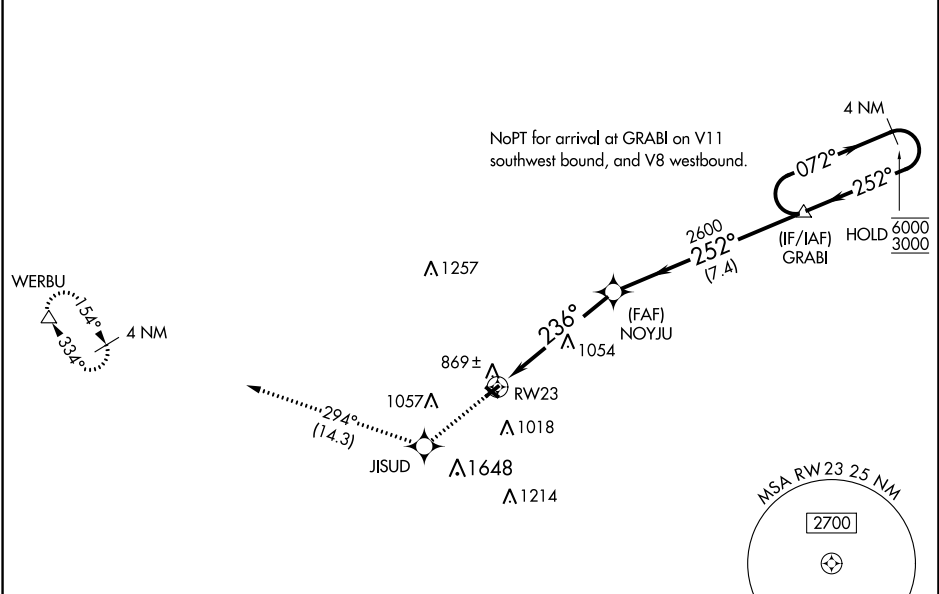

EC-2, 22 FEB 2024 to 21 MAR 2024

EC-2, 22 FEB 2024 to 21 MAR 2024

ELEV 836	TDZE 834
----------	----------

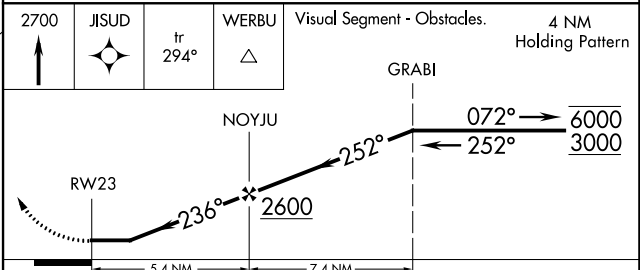
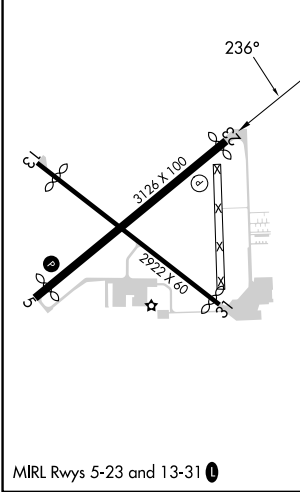

CATEGORY	A	B	C	D
LP MDA	1360-1	526 (600-1)	1360-1½ 526 (600-1½)	NA
LNAV MDA	1400-1	566 (600-1)	1400-1½ 566 (600-1½)	NA
<b>C</b> CIRCLING	1400-1	564 (600-1)	1940-3 1104 (1200-3)	NA

WAAS CH <b>77638</b> <b>W31A</b>	APP CRS <b>313°</b>	Rwy Idg <b>2821</b> TDZE <b>836</b> Apt Elev <b>836</b>
--	------------------------	---

# RNAV (GPS) RWY 31

SMITH FLD (SMD)

**⚠** Rwy 31 helicopter visibility reduction below 1 SM NA. DME/DME RNP-0.3 NA.  
**⚠** NA Procedure NA at night. When local altimeter setting not received, use Fort Wayne Intl altimeter setting and increase all MDA 40 feet, LP Cat C visibility 1/2 SM and LNAV Cat C visibility 1/2 SM.  
**⚠** MISSED APPROACH: Climb to 2700 direct GRUSS and on track 273° to WERBU and hold.

AWOS-3 <b>124.55</b>	FORT WAYNE APP CON <b>127.2 284.6</b>	UNICOM <b>122.8 (CTAF) 0</b>
-------------------------	--	---------------------------------

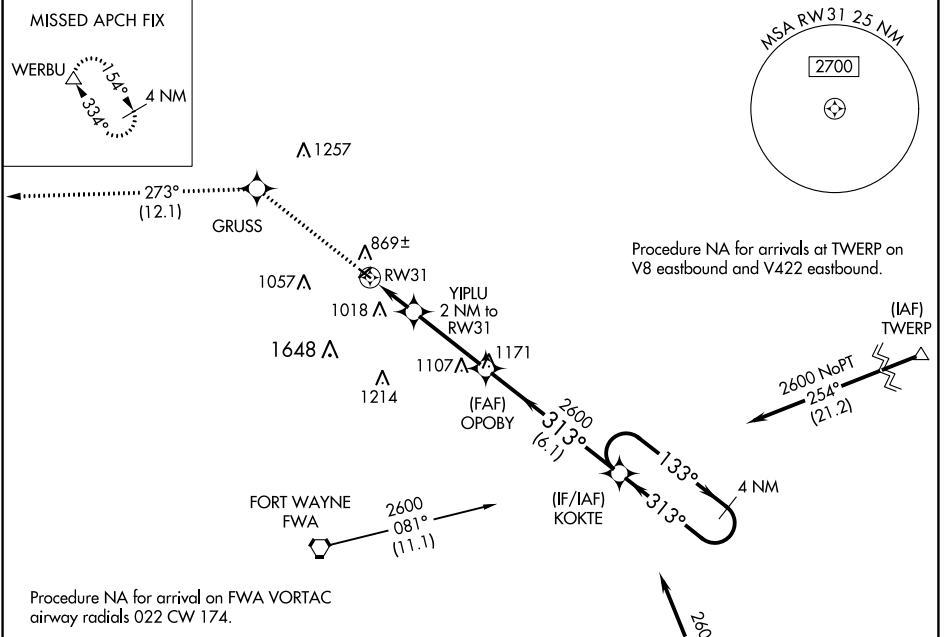

ELEV 836	TDZE 836
----------	----------

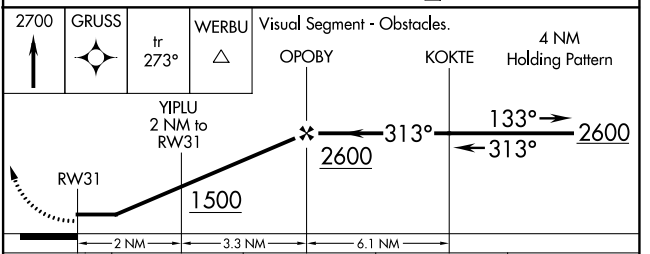
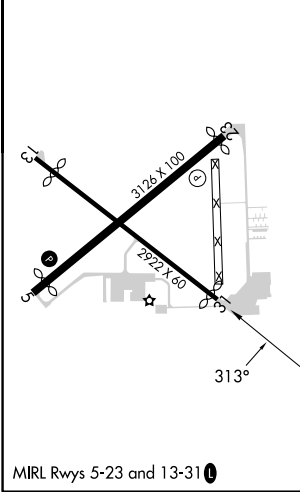

CATEGORY	A	B	C	D
LP MDA	1240-1	404 (500-1)	1240-1 1/8 404 (500-1 1/8)	NA
LNAV MDA	1260-1	424 (500-1)	1260-1 1/4 424 (500-1 1/4)	NA
<b>C</b> CIRCLING	1400-1	564 (600-1)	1940-3 1104 (1200-3)	NA

EC-2, 22 FEB 2024 to 21 MAR 2024

EC-2, 22 FEB 2024 to 21 MAR 2024

APP CRS	Rwy Idg	<b>3035</b>
<b>056°</b>	TDZE	<b>834</b>
	Apt Elev	<b>836</b>

# RNAV (GPS) RWY 5

SMITH FLD (SMD)

RNP APCH.

When local altimeter setting not received, use Fort Wayne Intl altimeter setting and increase all MDA 40 feet. Procedure NA at night. Rwy 5 helicopter visibility reduction below 1 SM NA.

MISSED APPROACH: Climb to 2700 direct INODY and on track 335° to IVUNY and on track 256° to WERBU and hold.

AWOS-3 <b>124.55</b>	FORT WAYNE APP CON <b>127.2 284.6</b>	UNICOM <b>122.8 (CTAF) 0</b>
-------------------------	--	---------------------------------

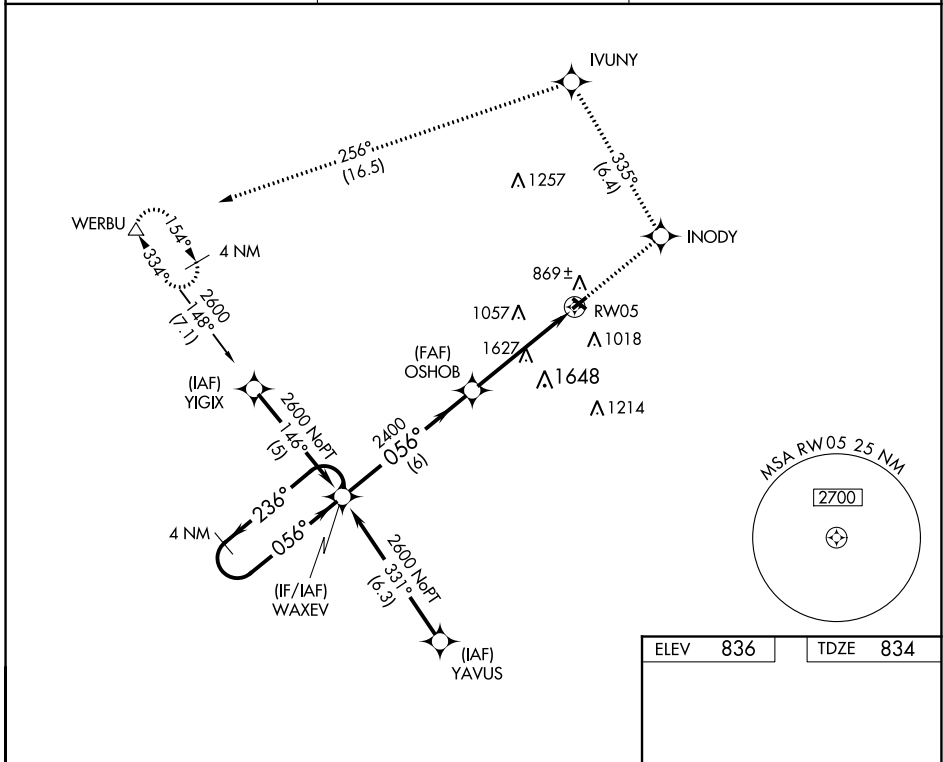

EC-2, 22 FEB 2024 to 21 MAR 2024

EC-2, 22 FEB 2024 to 21 MAR 2024

ELEV	<b>836</b>	TDZE	<b>834</b>
------	------------	------	------------

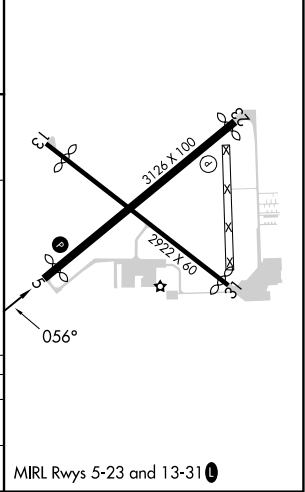
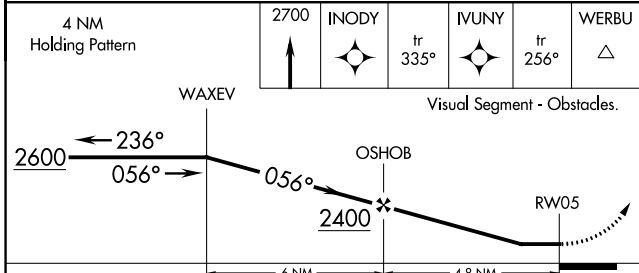

CATEGORY	A	B	C	D
LNVA MDA	1880-1¼ 1046 (1100-1¼)	1880-1½ 1046 (1100-1½)	1880-3 1046 (1100-3)	NA
CIRCLING	1880-1¼ 1044 (1100-1¼)	1880-1½ 1044 (1100-1½)	1940-3 1104 (1200-3)	NA

MIRL Rwy 5-23 and 13-31 0

VOR OLK <b>110.4</b>	APP CRS <b>114°</b>	Rwy Idg TDZE Apt Elev	<b>2623</b> <b>836</b> <b>836</b>
-------------------------	------------------------	-----------------------------	---

# VOR RWY 13

SMITH FLD (SMD)

**⚠** NA  
**⚠** -22°C

Rwy 13 helicopter visibility reduction below 1 SM NA. Procedure NA at night. When local altimeter setting not received, use Fort Wayne Intl altimeter setting and increase all MDA 40 feet and S-13 Cat C visibility 1/8 SM.

MISSED APPROACH: Climb to 1900 then climbing left turn to 2700 direct OLK VOR and hold.

AWOS-3 <b>124.55</b>	FORT WAYNE APP CON <b>127.2 284.6</b>	UNICOM <b>122.8 (CTAF) 0</b>
-------------------------	--	---------------------------------

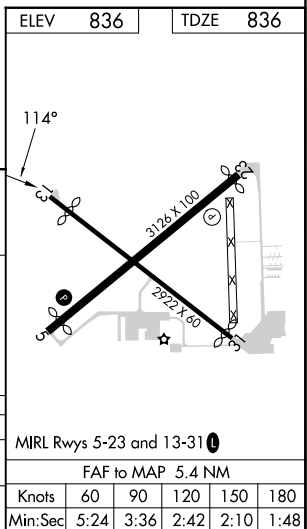
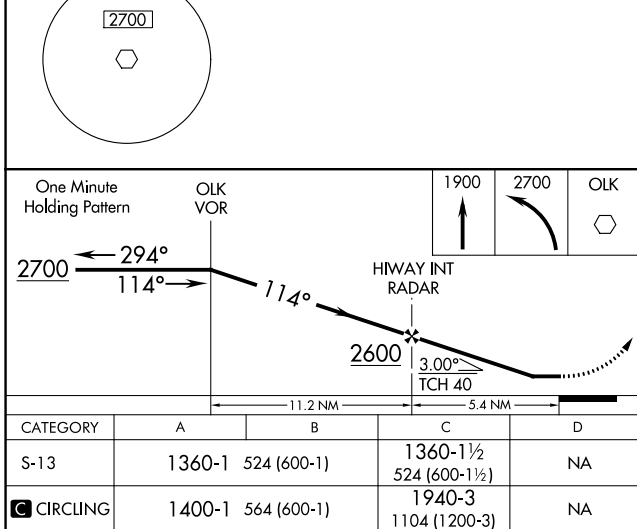
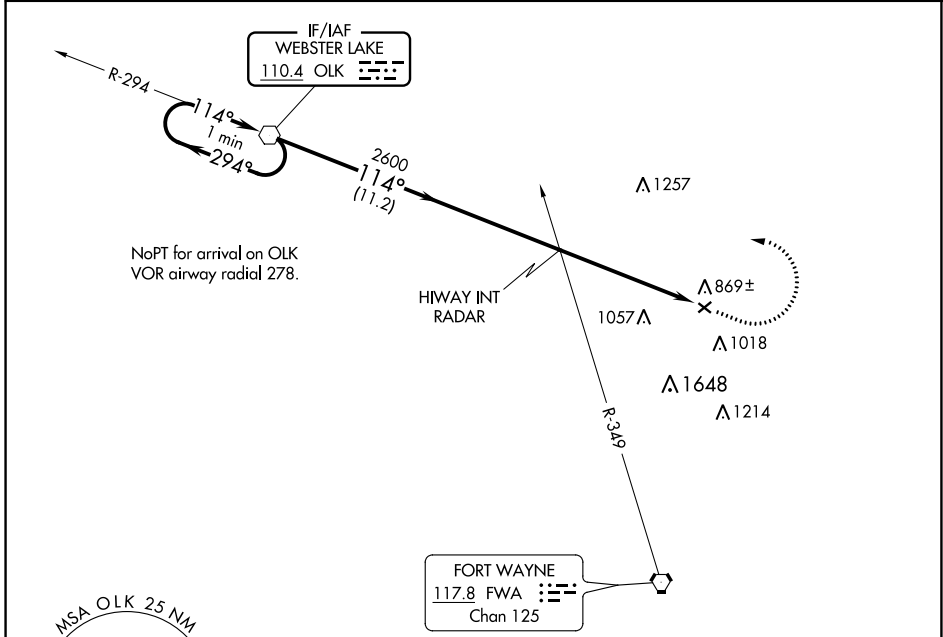

EC-2, 22 FEB 2024 to 21 MAR 2024

EC-2, 22 FEB 2024 to 21 MAR 2024

INSTRUMENT APPROACH PROCEDURE CHARTS

**IFR ALTERNATE AIRPORT MINIMUMS**

Pilots must review the IFR Alternate Minimums Notes to determine alternate airport suitability.

**△**NA designation on the approach chart means that pilots may not use that approach as an alternate due to unmonitored facility, absence of weather reporting service, or lack of adequate navigation coverage. Approaches with the **△**NA designation are not listed in this section. **△** designation on the approach chart indicates that the approach procedure has non-standard minimums (for aircraft other than helicopters) or restrictions (for all users) for its use as an alternate.

**Alternate Minima (ref: 14 CFR 91.169)**

	Precision Approach	Non-Precision Approach
Standard	<b>600-2</b>	<b>800-2</b>
<b>△</b> Non-Standard or restrictions	As indicated below	As indicated below
Helicopters	For the selected approach: Ceiling: 200' above published ceiling Visibility: the greater of 1 SM visibility or the published visibility	
US Military (USA/USN/USAF)	See Service Regulations	

**Note:** For alternate airport flight planning purposes, precision approach operations include: ILS, PAR, and GLS, and Non-Precision approach operations include: NDB, VOR, LOC, TACAN, LDA, SDF, ASR, RNAV (GPS) and RNAV (RNP).

**AKRON, OH**  
AKRON FULTON  
INTL (AKR).....**LOC Rwy 25**  
**NDB Rwy 25**  
**RNAV (GPS) Rwy 25**  
  
Category D, 800-2½.

**BATAVIA, OH**  
CLERMONT  
COUNTY (I69).....**RNAV (GPS) Rwy 4**  
**RNAV (GPS) Rwy 22**  
**VOR-B**  
  
NA when local weather not available.

**ANDERSON, IN**  
ANDERSON MUNI-DARLINGTON  
FLD (AID).....**ILS or LOC Rwy 30<sup>1</sup>**  
**RNAV (GPS) Rwy 12**  
**RNAV (GPS) Rwy 30**  
  
NA when local weather not available.  
<sup>1</sup>NA when control tower closed.

**BEDFORD, IN**  
VIRGIL I. GRISSOM  
MUNI (BFR).....**RNAV (GPS) Rwy 13**  
NA when local weather not available.

**ATHENS/ALBANY, OH**  
OHIO  
UNIVERSITY (UNI).....**RNAV (GPS) Rwy 7**  
**RNAV (GPS) Rwy 25**  
  
Category D, 800-2½.

**BELLEFONTAINE, OH**  
BELLEFONTAINE  
RGNL (EDJ).....**VOR Rwy 7**  
NA when local weather not available.  
Category D, 900-2¾.

**AUBURN, IN**  
DE KALB  
COUNTY (GWB).....**RNAV (GPS) Rwy 9**  
**RNAV (GPS) Rwy 27**  
**VOR-A**  
  
Category C, 900-2½; Category D, 900-2¾.

**BLOOMINGTON, IN**  
MONROE  
COUNTY (BMG).....**ILS or LOC/DME Rwy 35<sup>1</sup>**  
**RNAV (GPS) Rwy 17<sup>2</sup>**  
**RNAV (GPS) Rwy 24<sup>2</sup>**  
**RNAV (GPS) Rwy 35<sup>3</sup>**  
**VOR Rwy 17<sup>3</sup>**  
**VOR/DME Rwy 6<sup>23</sup>**

<sup>1</sup>ILS, LOC, Category D, 800-2½.  
<sup>2</sup>NA when local weather not available.  
<sup>3</sup>Category D, 800-2½.

22 FEB 2024 to 21 MAR 2024

22 FEB 2024 to 21 MAR 2024

NAME ALTERNATE MINIMUMS

**CAMBRIDGE, OH**

CAMBRIDGE MUNI (CDI).....RNAV (GPS) Rwy 4  
RNAV (GPS) Rwy 22

NA when local weather not available.  
Category C, 1100-3.

**CHILLICOTHE, OH**

ROSS COUNTY (RZT).....RNAV (GPS) Rwy 23

NA when local weather not available.  
Category C, 800-2¼; Category D, 900-2¼.

**CINCINNATI, OH**

CINCINNATI MUNI/LUNKEN

FLD (LUK).....ILS or LOC Rwy 21L<sup>12</sup>  
RNAV (GPS) Rwy 3R<sup>3</sup>  
RNAV (GPS) Rwy 21L<sup>4</sup>  
RNAV (GPS) Rwy 25<sup>5</sup>

NA when local weather not available.  
<sup>1</sup>NA when control tower closed.  
<sup>2</sup>LOC, Category B, 900-2; Category C, 900-2½;  
Category D, 1000-3.  
<sup>3</sup>Categories A, B, 900-2; Category C, 900-2½;  
Category D, 900-2¼.  
<sup>4</sup>Categories A, B, 900-2¼; Category C, 900-2½;  
Category D, 900-2¼.  
<sup>5</sup>Categories A, B, C, 900-2½; Category D, 900-2¼.

**CIRCLEVILLE, OH**

PICKAWAY COUNTY

MEML (CYO).....RNAV (GPS) Rwy 1  
RNAV (GPS) Rwy 19  
VOR Rwy 19

NA when local weather not available.

**CLEVELAND, OH**

BURKE

LAKEFRONT (BKL).....ILS or LOC Rwy 24R<sup>1</sup>  
RNAV (GPS) Rwy 24R

NA when local weather not available.  
<sup>1</sup>NA when control tower closed.

CUYAHOGA

COUNTY (CGF).....ILS or LOC Rwy 24<sup>1</sup>  
RNAV (GPS) Rwy 6<sup>2</sup>  
RNAV (GPS) Rwy 24<sup>3</sup>

<sup>1</sup>LOC, Category D, 800-2½.  
<sup>2</sup>Category D, 800-2¼.  
<sup>3</sup>Category D, 800-2½.

**COLUMBUS, IN**

COLUMBUS

MUNI (BAK).....RNAV (GPS) Rwy 5  
RNAV (GPS) Rwy 14<sup>1</sup>  
RNAV (GPS) Rwy 23  
RNAV (GPS) Rwy 32

NA when local weather not available.  
<sup>1</sup>Category D, 800-2½.

NAME ALTERNATE MINIMUMS

**COLUMBUS, OH**

BOLTON FLD (TZR).....ILS or LOC Rwy 4<sup>12</sup>  
NDB Rwy 4<sup>1</sup>  
RNAV (GPS) Rwy 22<sup>2</sup>

<sup>1</sup>NA when control tower closed.  
<sup>2</sup>NA when local weather not available.

JOHN GLENN COLUMBUS

INTL (CMH).....ILS or LOC Rwy 10L<sup>1</sup>  
ILS or LOC Rwy 10R<sup>1</sup>  
ILS or LOC Rwy 28L<sup>1</sup>  
ILS or LOC Rwy 28R<sup>1</sup>  
RNAV (GPS) Y Rwy 10L<sup>2</sup>  
RNAV (GPS) Y Rwy 10R<sup>2</sup>  
RNAV (GPS) Y Rwy 28L<sup>2</sup>  
RNAV (GPS) Y Rwy 28R<sup>2</sup>

<sup>1</sup>LOC, Category D, 800-2¼.  
<sup>2</sup>Category D, 800-2¼.

OHIO STATE

UNIVERSITY (OSU).....ILS or LOC Rwy 9R<sup>12</sup>  
NDB Rwy 9R<sup>3</sup>  
RNAV (GPS) Rwy 9R<sup>3</sup>  
RNAV (GPS) Rwy 27L<sup>3</sup>

NA when local weather not available.  
<sup>1</sup>LOC, Category D, 800-2¼.  
<sup>2</sup>NA when control tower closed.  
<sup>3</sup>Category D, 800-2¼.

RICKENBACKER

INTL (LCK).....ILS or LOC Rwy 5L  
ILS or LOC Rwy 23L  
RNAV (GPS) Rwy 5L  
RNAV (GPS) Rwy 5R  
RNAV (GPS) Rwy 23L  
RNAV (GPS) Rwy 23R

NA when local weather not available.

**CRAWFORDSVILLE, IN**

CRAWFORDSVILLE

RGNL (CFJ).....RNAV (GPS) Rwy 4  
RNAV (GPS) Rwy 22

NA when local weather not available.  
Category D, 800-2¼.

**DAYTON, OH**

DAYTON/WRIGHT

BROTHERS (MGY).....RNAV (GPS) Rwy 2  
RNAV (GPS) Rwy 20

NA when local weather not available.  
Category D, 800-2¼.

GREEN COUNTY/LEWIS A JACKSON

RGNL (GDK).....RNAV (GPS) Rwy 7  
RNAV (GPS) Rwy 25

NA when local weather not available.

JAMES M COX DAYTON

INTL (DAY).....ILS or LOC Rwy 6L  
ILS, Category D, 700-2.

22 FEB 2024 to 21 MAR 2024

22 FEB 2024 to 21 MAR 2024

NAME ALTERNATE MINIMUMS

**DEFIANCE, OH**

DEFIANCE  
MEML (DFI).....RNAV (GPS) Rwy 12  
Category D, 800-2¼.

**ELKHART, IN**

ELKHART  
MUNI (EKM).....ILS or LOC Rwy 27<sup>1</sup>  
RNAV (GPS) Rwy 9<sup>2</sup>  
RNAV (GPS) Rwy 18<sup>23</sup>  
RNAV (GPS) Rwy 27<sup>23</sup>  
RNAV (GPS) Rwy 36<sup>2</sup>  
VOR Rwy 9<sup>2</sup>

<sup>1</sup>ILS, NA when control tower closed. LOC, NA.  
<sup>2</sup>NA when local weather not available.  
<sup>3</sup>Category D, 900-2½.

**EVANSVILLE, IN**

EVANSVILLE  
RGNL (EVV).....ILS or LOC Rwy 4<sup>1</sup>  
ILS or LOC Rwy 22<sup>2</sup>

NA when control tower closed.  
<sup>1</sup>ILS, Categories A, B, 800-2; Categories C, D, 800-2½; LOC, Categories C, D, 800-2½.  
<sup>2</sup>NA when local weather not available.

**FINDLAY, OH**

FINDLAY (FDY).....RNAV (GPS) Rwy 7  
RNAV (GPS) Rwy 18  
RNAV (GPS) Rwy 25  
RNAV (GPS) Rwy 36  
VOR Rwy 7

NA when local weather not available.  
Category D, 800-2¼.

**FORT WAYNE, IN**

FORT WAYNE  
INTL (FWA).....ILS or LOC Rwy 5<sup>1</sup>  
ILS or LOC Rwy 32<sup>2</sup>  
RADAR-1<sup>3</sup>  
RNAV (GPS) Rwy 5<sup>3</sup>  
RNAV (GPS) Rwy 14<sup>4</sup>  
RNAV (GPS) Rwy 23<sup>3</sup>  
RNAV (GPS) Rwy 32<sup>4</sup>  
VOR or TACAN Rwy 5<sup>3</sup>  
VOR or TACAN Rwy 14<sup>3</sup>  
VOR or TACAN Rwy 23<sup>3</sup>

<sup>1</sup>ILS, Category C, 700-2; Category D, 800-2¼; Category E, 800-2½; LOC, Category D, 800-2¼; Category E, 800-2½.  
<sup>2</sup>LOC, Category D, 800-2¼, Category E, 800-2½.  
<sup>3</sup>Category D, 800-2¼, Category E, 800-2½.  
<sup>4</sup>Category D, 800-2¼.

SMITH FLD (SMD).....RNAV (GPS) Rwy 5  
Categories A, B, 1100-2; Category C, 1200-3.

**FOSTORIA, OH**

FOSTORIA METRO (FZI).....RNAV (GPS) Rwy 9  
NA when local weather not available.

NAME ALTERNATE MINIMUMS

**FRANKFORT, IN**

FRANKFORT CLINTON  
COUNTY RGNL (FKR).....RNAV (GPS) Rwy 27  
NA when local weather not available.

**FRENCH LICK, IN**

FRENCH LICK  
MUNI (FRH).....RNAV (GPS) Rwy 8  
RNAV (GPS) Rwy 26  
Category D, 800-2¼.

**GARY, IN**

GARY/CHICAGO  
INTL (GYG).....COPTER ILS or LOC Rwy 30<sup>1</sup>  
ILS or LOC Rwy 30<sup>123</sup>  
RNAV (GPS) Rwy 2<sup>24</sup>  
RNAV (GPS) Rwy 20<sup>4</sup>  
RNAV (GPS) Y Rwy 12<sup>24</sup>  
RNAV (GPS) Y Rwy 30<sup>24</sup>

<sup>1</sup>NA when control tower closed.  
<sup>2</sup>NA when local weather not available.  
<sup>3</sup>LOC, Category C, 900-2¼; Category D, 900-2¼.  
<sup>4</sup>Category C, 900-2¼; Category D, 900-2¼.

**GOSHEN, IN**

GOSHEN MUNI (GSH).....RNAV (GPS) Rwy 9  
RNAV (GPS) Rwy 27  
VOR Rwy 9  
NA when local weather not available.  
Category D, 800-2¼.

**HAMILTON, OH**

BUTLER COUNTY RGNL/HOGAN  
FLD (HAO).....ILS or LOC Rwy 29<sup>1</sup>  
RNAV (GPS) Rwy 11<sup>2</sup>  
RNAV (GPS) Rwy 29<sup>2</sup>  
NA when local weather not available.  
<sup>1</sup>LOC, Category D, 1200-3.  
<sup>2</sup>Category D, 1200-3.

**HUNTINGBURG, IN**

HUNTINGBURG (HNB).....RNAV (GPS) Rwy 9  
RNAV (GPS) Rwy 27  
NA when local weather not available.  
Category D, 900-2¼.

**HUNTINGTON, IN**

HUNTINGTON  
MUNI (HHG).....RNAV (GPS) Rwy 10<sup>1</sup>  
RNAV (GPS) Rwy 28<sup>1</sup>  
VOR-A  
Category D, 800-2¼.  
<sup>1</sup>NA when local weather not available.

**INDIANAPOLIS, IN**

EAGLE CREEK  
AIRPARK (EYE).....RNAV (GPS) Rwy 21  
VOR-A  
NA when local weather not available.

22 FEB 2024 to 21 MAR 2024

22 FEB 2024 to 21 MAR 2024



NAME ALTERNATE MINIMUMS

**INDIANAPOLIS, IN (CON'T)**

INDIANAPOLIS  
EXEC (TYQ).....RNAV (GPS) Rwy 18  
RNAV (GPS) Rwy 36  
VOR Rwy 18

NA when local weather not available.

INDIANAPOLIS

INTL (IND).....ILS or LOC Rwy 5L<sup>1</sup>  
ILS or LOC Rwy 5R<sup>1</sup>  
ILS or LOC Rwy 14<sup>2</sup>  
ILS or LOC Rwy 23L<sup>2</sup>  
ILS or LOC Rwy 23R<sup>1</sup>  
ILS or LOC Rwy 32<sup>1</sup>  
RNAV (GPS) Y Rwy 5L<sup>3</sup>  
RNAV (GPS) Y Rwy 5R<sup>3</sup>  
RNAV (GPS) Y Rwy 14<sup>3</sup>  
RNAV (GPS) Y Rwy 23L<sup>3</sup>  
RNAV (GPS) Y Rwy 23R<sup>3</sup>  
RNAV (GPS) Y Rwy 32<sup>3</sup>

<sup>1</sup>ILS, Categories A, B, C, 700-2;  
Category D, 800-2½; LOC, Category D, 800-2½.

<sup>2</sup>LOC, Category D, 800-2½.

<sup>3</sup>Category D, 800-2½.

INDIANAPOLIS

RGNL (MQJ).....RNAV (GPS) Rwy 16  
RNAV (GPS) Rwy 25<sup>1</sup>

Category D, 800-2½.

<sup>1</sup>NA when local weather not available.

INDY SOUTH

GREENWOOD (HFY).....RNAV (GPS) Rwy 1  
Category D, 1100-3.

**JACKSON, OH**

JAMES A RHODES (JRO).....RNAV (GPS) Rwy 1  
RNAV (GPS) Rwy 19

NA when local weather not available.

Categories C, D, 1000-3.

**JEFFERSONVILLE, IN**

CLARK RGNL (JVY).....RNAV (GPS) Rwy 18  
RNAV (GPS) Rwy 36

NA when local weather not available.

**KENDALLVILLE, IN**

KENDALLVILLE  
MUNI (C62).....RNAV (GPS) Rwy 10  
RNAV (GPS) Rwy 28

NA when local weather not available.

**KNOX, IN**

STARKE COUNTY (OXI).....RNAV (GPS) Rwy 18

NA when local weather not available.

Category D, 800-2½.

NAME ALTERNATE MINIMUMS

**KOKOMO, IN**

KOKOMO MUNI (OKK).....RNAV (GPS) Rwy 5  
RNAV (GPS) Rwy 14<sup>1</sup>  
RNAV (GPS) Rwy 23  
RNAV (GPS) Rwy 32<sup>1</sup>

NA when local weather not available.

<sup>1</sup>Category D, 900-2½.

**LA PORTE, IN**

LA PORTE  
MUNI (PPO).....RNAV (GPS) Rwy 2  
RNAV (GPS) Rwy 20

NA when local weather not available.

Category C, 800-2¼, Category D, 800-2½.

**LAFAYETTE, IN**

PURDUE  
UNIVERSITY (LAF).....ILS or LOC Rwy 10<sup>12</sup>  
RNAV (GPS) Rwy 10<sup>34</sup>  
RNAV (GPS) Rwy 28<sup>34</sup>  
VOR-A<sup>34</sup>

<sup>1</sup>LOC, Category D, 900-2¾.

<sup>2</sup>NA when control tower closed.

<sup>3</sup>NA when local weather not available.

<sup>4</sup>Category D, 900-2¾.

**LANCASTER, OH**

FAIRFIELD  
COUNTY (LHQ).....RNAV (GPS) Rwy 10<sup>1</sup>  
RNAV (GPS) Rwy 28

NA when local weather not available.

<sup>1</sup>Category C, 900-2½.

**LIMA, OH**

LIMA ALLEN  
COUNTY (AOH).....RNAV (GPS) Rwy 10  
RNAV (GPS) Rwy 28<sup>1</sup>

NA when local weather not available.

<sup>1</sup>Category D, 900-2¾.

**LONDON, OH**

MADISON COUNTY (UYF).....RNAV (GPS) Rwy 9  
RNAV (GPS) Rwy 27

NA when local weather not available.

Category D, 800-2½.

**LORAIN/ELYRIA, OH**

LORAIN COUNTY  
RGNL (LPR).....ILS or LOC Rwy 7<sup>1</sup>  
VOR-A

NA when local weather not available.

<sup>1</sup>ILS, Categories C, D, 700-2.

**MADISON, IN**

MADISON MUNI (IMS).....RNAV (GPS) Rwy 21  
RNAV (GPS) Y Rwy 3

NA when local weather not available.

22 FEB 2024 to 21 MAR 2024

22 FEB 2024 to 21 MAR 2024

NAME ALTERNATE MINIMUMS

**MANSFIELD, OH**

MANSFIELD LAHM  
RGNL (MFD).....ILS or LOC Rwy 32<sup>13</sup>  
NDB Rwy 32<sup>4</sup>  
RNAV (GPS) Rwy 5<sup>4</sup>  
RNAV (GPS) Rwy 14<sup>2</sup>  
RNAV (GPS) Rwy 23<sup>4</sup>  
RNAV (GPS) Rwy 32<sup>2</sup>  
VOR Rwy 14<sup>4</sup>  
VOR Rwy 32<sup>4</sup>

<sup>1</sup>NA when control tower closed.  
<sup>2</sup>NA when local weather not available.  
<sup>3</sup>LOC, Category D, 800-2¼.  
<sup>4</sup>Category D, 800-2¼.

**MARION, OH**

MARION MUNI (MNN).....RNAV (GPS) Rwy 7  
RNAV (GPS) Rwy 13  
RNAV (GPS) Rwy 25  
VOR-A

NA when local weather not available.  
Category D, 900-2¾.

**MARYSVILLE, OH**

UNION COUNTY (MRT).....RNAV (GPS) Rwy 9  
RNAV (GPS) Rwy 27

NA when local weather not available.

**MICHIGAN CITY, IN**

MICHIGAN CITY MUNI-PHILLIPS  
FLD (MGC).....RNAV (GPS) Rwy 20  
Category C, 900-2¾.

**MIDDLETOWN, OH**

MIDDLETOWN RGNL/HOOK  
FLD (MWO).....RNAV (GPS) Rwy 5  
RNAV (GPS) Rwy 23

NA when local weather not available.  
Category C, 1100-3; Category D, 1200-3.

**MILLERSBURG, OH**

HOLMES COUNTY (10G).....RNAV (GPS) Rwy 9  
RNAV (GPS) Rwy 27

NA when local weather not available.

**MOUNT VERNON, OH**

KNOX  
COUNTY (413).....RNAV (GPS) Rwy 10  
NA when local weather not available.

**MONTICELLO, IN**

WHITE  
COUNTY (MCX).....RNAV (GPS) Rwy 18  
RNAV (GPS) Rwy 36

NA when local weather not available.  
Category C, 900-2¾; Category D, 900-2¾.

NAME ALTERNATE MINIMUMS

**MUNCIE, IN**

DELAWARE  
COUNTY RGNL (MIE).....ILS or LOC Rwy 31<sup>1</sup>  
RNAV (GPS) Rwy 3  
RNAV (GPS) Rwy 14  
RNAV (GPS) Rwy 21  
RNAV (GPS) Rwy 32  
VOR Rwy 14  
VOR Rwy 21

NA when local weather not available.  
<sup>1</sup>NA when control tower closed.

**NEW PHILADELPHIA, OH**

HARRY CLEVER  
FLD (PHD).....VOR-A  
Categories A, B, 900-2; Category C, 900-2¾.

**NEWARK, OH**

NEWARK-HEATH (VTA).....RNAV (GPS) Rwy 9<sup>1</sup>  
RNAV (GPS) Rwy 27<sup>2</sup>  
VOR-A<sup>34</sup>

<sup>1</sup>Category C, 900-2¾; Category D, 900-2¾.  
<sup>2</sup>Categories A, B, 900-2; Category C, 900-2¾;  
Category D, 900-2¾.  
<sup>3</sup>Categories A, B, 1100-2; Categories C, D, 1100-3.  
<sup>4</sup>NA when local weather not available.

**PLYMOUTH, IN**

PLYMOUTH MUNI (C65).....RNAV (GPS) Rwy 10  
NA when local weather not available.

**PORT CLINTON, OH**

ERIE-OTTAWA  
INTL (PCW).....RNAV (GPS) Rwy 9  
RNAV (GPS) Rwy 27

NA when local weather not available.  
Category D, 1000-3.

**PORTLAND, IN**

PORTLAND MUNI (PLD).....RNAV (GPS) Rwy 9  
RNAV (GPS) Rwy 27<sup>1</sup>

Category D, 800-2¼.  
<sup>1</sup>NA when local weather not available.

**RAVENNA, OH**

PORTAGE  
COUNTY (POV).....RNAV (GPS) Rwy 9  
RNAV (GPS) Rwy 27  
VOR-A

NA when local weather not available.

**RENSELAER, IN**

JASPER  
COUNTY (RZL).....RNAV (GPS) Rwy 18  
RNAV (GPS) Rwy 36

NA when local weather not available.  
Category C, 800-2¼.

22 FEB 2024 to 21 MAR 2024

22 FEB 2024 to 21 MAR 2024

NAME ALTERNATE MINIMUMS

**ROCHESTER, IN**

FULTON COUNTY (RCR).....RNAV (GPS) Rwy 11  
RNAV (GPS) Rwy 29

NA when local weather not available.  
Category D, 900-2¼.

**SHELBYVILLE, IN**

SHELBYVILLE MUNI (GEZ).....RNAV (GPS) Rwy 1¹  
RNAV (GPS) Rwy 19¹  
VOR Rwy 19

Category D, 800-2¼.  
¹NA when local weather not available.

**SOUTH BEND, IN**

SOUTH BEND INTL (SBN).....ILS or LOC Rwy 9R¹²  
ILS or LOC Rwy 27L¹²  
RNAV (GPS) Rwy 9L³  
RNAV (GPS) Rwy 9R³  
RNAV (GPS) Rwy 18³⁴  
RNAV (GPS) Rwy 27L³  
RNAV (GPS) Rwy 27R³  
RNAV (GPS) Rwy 36³  
VOR Rwy 18³

¹NA when control tower closed.  
²LOC, Category D, 800-2¼.  
³Category D, 800-2¼.  
⁴NA when local weather not available.

**SPRINGFIELD, OH**

SPRINGFIELD/BECKLEY MUNI (SGH).....RNAV (GPS) Rwy 6  
RNAV (GPS) Rwy 15  
RNAV (GPS) Rwy 24  
RNAV (GPS) Rwy 33

NA when local weather not available.

**STEUBENVILLE, OH**

GEARY A BATES/JEFFERSON COUNTY AIRPARK (2G2).....RNAV (GPS) Rwy 14  
RNAV (GPS) Rwy 32

Category C, 800-2¼.

**TERRE HAUTE, IN**

TERRE HAUTE RGNL (HUF).....ILS or LOC Rwy 5¹  
RADAR-1²³  
RNAV (GPS) Rwy 5⁴  
RNAV (GPS) Rwy 14⁴  
RNAV (GPS) Rwy 23⁴  
RNAV (GPS) Rwy 32⁴  
VOR Rwy 5⁴

¹LOC, NA when local weather not available.  
²Category E, 800-2½.  
³NA when control tower closed.  
⁴NA when local weather not available.

NAME ALTERNATE MINIMUMS

**TOLEDO, OH**

TOLEDO EXEC (TDZ).....RNAV (GPS) Rwy 4  
RNAV (GPS) Rwy 32

NA when local weather not available.  
Category D, 800-2¼.

EUGENE F KRANZ TOLEDO

EXPRESS (TOL).....ILS Z or LOC Z Rwy 7¹  
ILS Z or LOC Z Rwy 25²³  
RADAR-1⁴  
RNAV (GPS) Rwy 7⁴  
RNAV (GPS) Rwy 16⁵  
RNAV (GPS) Rwy 25⁴  
RNAV (GPS) Rwy 34⁵

¹ILS, NA when local weather not available; LOC, NA.  
²ILS, LOC, NA when local weather not available  
³LOC, Category D, 800-2¼; Category E, 800-2½.  
⁴Category D, 800-2¼, Category E, 800-2½.  
⁵Category D, 800-2¼.

**URBANA, OH**

GRIMES FLD (I74).....RNAV (GPS) Rwy 2  
RNAV (GPS) Rwy 20  
VOR-A

NA when local weather not available.

**VALPARAISO, IN**

PORTER COUNTY RGNL (VPZ).....ILS or LOC Rwy 27¹  
RNAV (GPS) Rwy 9²  
RNAV (GPS) Rwy 18  
RNAV (GPS) Rwy 27²

NA when local weather not available.  
¹LOC, Category D, 900-2¾.  
²Category D, 900-2¾.

**VAN WERT, OH**

VAN WERT COUNTY (VNW).....RNAV (GPS) Rwy 9  
RNAV (GPS) Rwy 27

NA when local weather not available.  
Category D, 900-2¼.

**WARSAW, IN**

WARSAW MUNI (ASW).....RNAV (GPS) Rwy 9  
RNAV (GPS) Rwy 27

NA when local weather not available.

**WASHINGTON, IN**

DAVIESS COUNTY (DCY).....RNAV (GPS) Rwy 18  
NA when local weather not available.  
Category D, 900-2¾.

**WASHINGTON COURT HOUSE, OH**

FAYETTE COUNTY (I23).....NDB Rwy 23  
NA when local weather not available.  
Category D, 800-2¼.

24025

NAME ALTERNATE MINIMUMS

NAME ALTERNATE MINIMUMS

**WILLOUGHBY, OH**

LAKE COUNTY

EXEC (LNN).....RNAV (GPS) Rwy 5<sup>1</sup>  
RNAV (GPS) Rwy 10<sup>2</sup>  
RNAV (GPS) Rwy 23<sup>3</sup>  
RNAV (GPS) Rwy 28<sup>3</sup>

NA when local weather not available.

<sup>1</sup>Categories A, B, 900-2; Category C, 900-2½.

<sup>2</sup>Categories A, B, 1000-2; Category C, 1000-2½.

<sup>3</sup>Category C, 900-2½.

**WILMINGTON, OH**

WILMINGTON

AIR PARK (ILN).....ILS or LOC Rwy 4L<sup>12</sup>  
ILS or LOC Rwy 4R<sup>12</sup>  
ILS or LOC Rwy 22L<sup>12</sup>  
ILS or LOC Rwy 22R<sup>23</sup>  
RNAV (GPS) Rwy 4L<sup>4</sup>  
RNAV (GPS) Rwy 22R<sup>4</sup>

NA when local weather not available.

<sup>1</sup>ILS, NA when control tower closed.

<sup>2</sup>LOC, Category C, 800-2¼; Category D, 800-2½.

<sup>3</sup>NA when control tower closed.

<sup>4</sup>Category C, 800-2¼; Category D, 800-2½.

**WOOSTER, OH**

WAYNE COUNTY (BJJ).....

RNAV (GPS) Rwy 10  
RNAV (GPS) Rwy 28  
VOR Rwy 10  
VOR Rwy 28

NA when local weather not available.

Category D, 800-2¼.

**YOUNGSTOWN/WARREN, OH**

YOUNGSTOWN/WARREN

RGNL (YNG).....RADAR-1

NA when Youngstown approach control closed.

**ZANESVILLE, OH**

ZANESVILLE

MUNI (ZZV).....RNAV (GPS) Rwy 4<sup>1</sup>  
RNAV (GPS) Rwy 22<sup>1</sup>  
VOR Rwy 4<sup>1</sup>  
VOR Rwy 22<sup>2</sup>

NA when local weather not available.

<sup>1</sup>Category D, 800-2¼.

<sup>2</sup>Categories A, B, 900-2; Category C, 900-2½;

Category D, 900-2½.

22 FEB 2024 to 21 MAR 2024

22 FEB 2024 to 21 MAR 2024

24025

M7

# TAKEOFF MINIMUMS, (OBSTACLE) DEPARTURE PROCEDURES, AND DIVERSE VECTOR AREA (RADAR VECTORS)

24025

INSTRUMENT APPROACH PROCEDURE CHARTS

## IFR TAKEOFF MINIMUMS AND (OBSTACLE) DEPARTURE PROCEDURES

### Civil Airports and Selected Military Airports

ALL USERS: Airports that have Departure Procedures (DPs) designed specifically to assist pilots in avoiding obstacles during the climb to the minimum enroute altitude, and/or airports that have civil IFR takeoff minimums other than standard, are listed below. Takeoff Minimums and Departure Procedures apply to all runways unless otherwise specified. An entry may also be listed that contains only Takeoff Obstacle Notes. Altitudes, unless otherwise indicated, are minimum altitudes in MSL.

DPs specifically designed for obstacle avoidance are referred to as Obstacle Departure Procedures (ODPs) and are textually described below, or published separately as a graphic procedure. If the ODP is published as a graphic procedure, its name will be listed below, and it can be found in either this volume (civil), or the applicable military volume, as appropriate. Users will recognize graphic obstacle DPs by the term "(OBSTACLE)" included in the procedure title; e.g., TETON TWO (OBSTACLE). If not specifically assigned an ODP, SID, or RADAR vector as part of an IFR clearance, an ODP may be required to be flown for obstacle clearance, even though not specifically stated in the IFR clearance. When doing so in this manner, ATC should be informed when the ODP being used contains a specified route to be flown, restrictions before turning, and/or altitude restrictions.

Some ODPs, which are established solely for obstacle avoidance, require a climb in visual conditions to cross the airport, a fix, or a NAVAID in a specified direction, at or above a specified altitude. These procedures are called Visual Climb Over Airport (VCOA). To ensure safe and efficient operations, the pilot must verbally request approval from ATC to fly the VCOA when requesting their IFR clearance.

At some locations where an ODP has been established, a diverse vector area (DVA) may be created to allow RADAR vectors to be used in lieu of an ODP. DVA information will state that headings will be as assigned by ATC and climb gradients, when applicable, will be published immediately following the specified departure procedure.

Graphic DPs designed by ATC to standardize traffic flows, ensure aircraft separation and enhance capacity are referred to as "Standard Instrument Departures (SIDs)". SIDs also provide obstacle clearance and are published under the appropriate airport section. ATC clearance must be received prior to flying a SID.

CIVIL USERS NOTE: Title 14 Code of Federal Regulations Part 91 prescribes standard takeoff rules and establishes takeoff minimums for certain operators as follows: (1) For aircraft, other than helicopters, having two engines or less – one statute mile visibility. (2) For aircraft having more than two engines – one-half statute mile visibility. (3) For helicopters – one-half statute mile visibility. These standard minima apply in the absence of any different minima listed below.

MILITARY USERS NOTE: Civil (nonstandard) takeoff minima are published below. For military takeoff minima, refer to appropriate service directives.

## AKRON, OH

### AKRON-CANTON RGNL (CAK)

#### TAKEOFF MINIMUMS AND (OBSTACLE) DEPARTURE PROCEDURES

AMDT 6 18NOV10 (10322) (FAA)

##### TAKEOFF OBSTACLE NOTES:

**Rwy 1**, multiple trees beginning 2756' from DER, 447' left of centerline, up to 116' AGL/1316' MSL.

Power lines beginning 3215' from DER, left and right of centerline, up to 80' AGL/1289' MSL.

**Rwy 5**, multiple trees beginning 840' from DER, 550' right of centerline, up to 116' AGL/1336' MSL.

Tree 577' from DER, 561' left of centerline, 46' AGL/1256' MSL.

**Rwy 19**, trees beginning 1998' from DER, 817' left of centerline, up to 100' AGL/1290' MSL.

### AKRON FULTON INTL (AKR)

#### TAKEOFF MINIMUMS AND (OBSTACLE) DEPARTURE PROCEDURES

AMDT 2A 08SEP22 (22307) (FAA)

##### TAKEOFF MINIMUMS:

**Rwy 7**, 300-1% or std. w/min. climb of 230' per NM to 1400 or alternatively, with std. takeoff minimums and a normal 200' per NM climb gradient, takeoff must occur no later than 1800' prior to DER.

**Rwy 25**, 300-1% or std. w/min. climb of 705' per NM to 1500.

##### DEPARTURE PROCEDURE:

**Rwy 25**, climb on heading 249° to 2600 before turning right.

##### TAKEOFF OBSTACLE NOTES:

**Rwy 7**, terrain 45' from DER, 257' right of centerline, 1073' MSL.

Vehicles on road 62' from DER, 460' right of centerline, 1090' MSL.

Vehicles on road 90' from DER, 358' right of centerline, 1091' MSL.

Vehicles on road beginning 179' from DER, 397' right of centerline, up to 1095' MSL.

Terrain 196' from DER, 493' left of centerline, 1068' MSL.

Fence 251' from DER, 544' left of centerline, 7' AGL/1077' MSL.

Tree, terrain, vehicles on road, vegetation, fence beginning 295' from DER, on centerline, up to 1126' MSL.

Fence 372' from DER, 490' left of centerline, 8' AGL/1080' MSL.

Vehicles on road, terrain beginning 397' from DER, 317' left of centerline, up to 1088' MSL.

Pole, terrain, vehicles on road beginning 476' from DER, 104' left of centerline, up to 34' AGL/1106' MSL.

Tree, terrain, vehicles on road beginning 566' from DER, 7' left of centerline, up to 1134' MSL.

Pole, terrain beginning 572' from DER, 114' right of centerline, up to 1127' MSL.

CON'T

# TAKEOFF MINIMUMS, (OBSTACLE) DEPARTURE PROCEDURES, AND DIVERSE VECTOR AREA (RADAR VECTORS)

24025

EC-2

# TAKEOFF MINIMUMS, (OBSTACLE) DEPARTURE PROCEDURES, AND DIVERSE VECTOR AREA (RADAR VECTORS)

24025

## AKRON, OH (CON'T)

### AKRON FULTON INTL (AKR) (CON'T)

**Rwy 7 (CON'T)**, poles, terrain, vehicles on road beginning 654' from DER, 1' right of centerline, up to 32' AGL/1141' MSL.  
Trees, vehicles on road, poles, terrain, building, fence, sign beginning 692' from DER, 75' left of centerline, up to 1171' MSL.  
Tree, vehicles on road beginning 905' from DER, 256' right of centerline, up to 1162' MSL.  
Trees, vehicles on road, terrain, poles, buildings beginning 944' from DER, 14' left of centerline, up to 1177' MSL.  
Trees, vehicles on road, terrain, fence, pole, building beginning 985' from DER, 2' right of centerline, up to 1175' MSL.  
Trees, vehicles on road, sign, building, terrain beginning 1273' from DER, 13' left of centerline, up to 1178' MSL.  
Trees, terrain, poles, fence, vehicles on road, building beginning 1432' from DER, 11' left of centerline, up to 1192' MSL.  
Tree, vehicles on road, terrain, fence, pole beginning 1459' from DER, 1' right of centerline, up to 1181' MSL.  
Trees, buildings, vehicles on road, poles, fence beginning 1857' from DER, 18' right of centerline, up to 1192' MSL.  
Trees, terrain, fence, vehicles on road, buildings, poles, vegetation beginning 1887' from DER, 6' left of centerline, up to 1198' MSL.  
Trees, vehicles on road, buildings, poles beginning 2277' from DER, 4' right of centerline, up to 1195' MSL.  
Trees, buildings, poles beginning 2727' from DER, 1' right of centerline, up to 1197' MSL.  
Building 6043' from DER, 460' left of centerline, 123' AGL/1213' MSL.  
Tree 1.1 NM from DER, 701' right of centerline, 1247' MSL.  
Trees beginning 1.1 NM from DER, 200' right of centerline, up to 1258' MSL.  
Tree 1.2 NM from DER, 301' right of centerline, 1254' MSL.  
**Rwy 25**, tree 53' from DER, 497' right of centerline, 1091' MSL.  
Vehicles on road, terrain beginning 66' from DER, 69' right of centerline, up to 1092' MSL.  
Tree, vehicles on road, terrain beginning 100' from DER, 3' right of centerline, up to 1101' MSL.  
Vehicles on road 133' from DER, 33' left of centerline, 1093' MSL.  
Trees, fence, terrain beginning 170' from DER, 292' right of centerline, up to 1119' MSL.  
Vehicles on road beginning 199' from DER, 130' left of centerline, up to 1094' MSL.  
Trees, terrain beginning 215' from DER, 235' right of centerline, up to 1124' MSL.  
Vehicles on road beginning 264' from DER, 225' left of centerline, up to 1095' MSL.  
Vehicles on road 375' from DER, 403' left of centerline, 1096' MSL.  
Tree 503' from DER, 541' left of centerline, 1108' MSL.  
Tree 573' from DER, 473' right of centerline, 1142' MSL.  
Trees, terrain, vehicles on road, fence, NAVAID, vegetation beginning 594' from DER, 23' right of centerline, up to 1165' MSL.  
Trees beginning 614' from DER, 493' left of centerline, up to 1122' MSL.  
Trees, fence, vehicles on road, vegetation, tank beginning 687' from DER, 3' left of centerline, up to 1156' MSL.  
Trees, vegetation, vehicles on road beginning 1405' from DER, on centerline, up to 1166' MSL.  
Trees, vegetation beginning 1590' from DER, 103' right of centerline, up to 1168' MSL.  
Trees, vegetation beginning 1612' from DER, 8' right of centerline, up to 1192' MSL.  
Pole, tree, vehicles on road, vegetation beginning 1671' from DER, 61' left of centerline, up to 37' AGL/1157' MSL.  
Trees, vegetation beginning 1679' from DER, 12' right of centerline, up to 1208' MSL.  
Trees, vegetation, poles beginning 1737' from DER, 52' left of centerline, up to 1172' MSL.  
Trees, vegetation, terrain, fence, building beginning 1745' from DER, 66' right of centerline, up to 1221' MSL.  
Tree 1785' from DER, 406' left of centerline, 1176' MSL.  
Tree, vegetation, terrain, poles, fence, vehicles on road, building beginning 1786' from DER, 6' left of centerline, up to 1185' MSL.  
Trees, terrain, vegetation, vehicles on road, buildings, poles, fence, signs, tower beginning 1948' from DER, 6' right of centerline, up to 64' AGL/1228' MSL.  
Tree, vegetation, terrain, pole beginning 2056' from DER, 76' left of centerline, up to 1215' MSL.  
Trees, vegetation, vehicles on road, terrain, pole beginning 2103' from DER, 17' left of centerline, up to 1225' MSL.  
Trees, buildings, vegetation, terrain, vehicles on road, poles fence, stack, tank, sign beginning 2349' from DER, 6' left of centerline, up to 1227' MSL.  
Antenna 1.3 NM from DER, 440' left of centerline, 307' AGL/1339' MSL.  
Tower 1.3 NM from DER, 215' left of centerline, 305' AGL/1343' MSL.

## ANDERSON, IN

### ANDERSON MUNI-DARLINGTON FLD (AID)

#### TAKEOFF MINIMUMS AND (OBSTACLE) DEPARTURE PROCEDURES

AMDT1 10MAR11 (21112) (FAA)

##### TAKEOFF MINIMUMS:

**Rwy 30**, 300-1/4 or std. w/min. climb of 220' per NM to 1200, or alternatively, with std. takeoff minimums and a normal 200' per NM climb gradient, takeoff must occur no later than 1500' prior to DER.

##### TAKEOFF OBSTACLE NOTES:

**Rwy 12**, pole and trees beginning 509' from DER, 519' left of centerline, up to 100' AGL/1005' MSL.

Trees beginning 1947' from DER, 446' right of centerline, up to 100' AGL/1010' MSL.

Railroad 944' from DER, left and right of centerline, up to 23' AGL/945' MSL.

**Rwy 18**, trees beginning 437' from DER, 169' left of centerline, up to 100' AGL/951' MSL.

Trees beginning 440' from DER, 159' right of centerline, up to 100' AGL/1015' MSL.

Vehicles on road beginning 373' from DER, left and right of centerline, up to 15' AGL/922' MSL.

Terrain 417' from DER, 299' left of centerline, 0' AGL/918' MSL.

**Rwy 30**, tower and trees beginning 1516' from DER, 519' left of centerline, up to 161' AGL/1057' MSL.

Trees beginning 389' from DER, 344' right of centerline, up to 100' AGL/1009' MSL.

Vehicles on road beginning 152' from DER, left and right of centerline, up to 15' AGL/884' MSL.

**Rwy 36**, trees beginning 850' from DER, 133' left of centerline, up to 100' AGL/999' MSL.

Building and trees beginning 277' from DER, 361' right of centerline, up to 100' AGL/1009' MSL.

Vehicles on road beginning 165' from DER, left and right of centerline, up to 15' AGL/925' MSL.

# TAKEOFF MINIMUMS, (OBSTACLE) DEPARTURE PROCEDURES, AND DIVERSE VECTOR AREA (RADAR VECTORS)

24025

**TAKEOFF MINIMUMS, (OBSTACLE) DEPARTURE PROCEDURES, AND**

  
**DIVERSE VECTOR AREA (RADAR VECTORS)**

24025

**ANGOLA, IN****TRI-STATE STEUBEN COUNTY (ANQ)****TAKEOFF MINIMUMS AND (OBSTACLE) DEPARTURE PROCEDURES**

AMDT 1 31DEC20 (20366) (FAA)

**TAKEOFF MINIMUMS:****Rwy 5**, 300-1¼ or std. w/ min. climb of 360' per NM to 1300.**TAKEOFF OBSTACLE NOTES:****Rwy 5**, fence, terrain beginning 8' from DER, 268' left of centerline, up to 6' AGL/1003' MSL.

Tree 9' from DER, 460' right of centerline, 1036' MSL.

Trees beginning 170' from DER, 335' left of centerline, up to 1027' MSL.

Trees beginning 237' from DER, 88' right of centerline, up to 1048' MSL.

Trees beginning 655' from DER, 292' right of centerline, up to 1075' MSL.

Trees beginning 845' from DER, 398' left of centerline, up to 1034' MSL.

Tree 1013' from DER, 671' left of centerline, 1040' MSL.

Trees beginning 1092' from DER, 585' left of centerline, up to 1074' MSL.

Tree 1312' from DER, 800' right of centerline, 1078' MSL.

Trees beginning 1397' from DER, 148' right of centerline, up to 1097' MSL.

Trees beginning 1709' from DER, 257' left of centerline, up to 1076' MSL.

Tree 1739' from DER, 928' right of centerline, 1098' MSL.

Trees, buildings, pole beginning 1740' from DER, 202' right of centerline, up to 1099' MSL.

Trees beginning 1828' from DER, 35' left of centerline, up to 1079' MSL.

Trees, poles, buildings, catenary beginning 1895' from DER, 18' right of centerline, up to 1103' MSL.

Trees, fence, terrain, pole beginning 1984' from DER, 14' left of centerline, up to 1106' MSL.

Trees, fence, poles, terrain, buildings, vehicles on traverse way beginning 2205' from DER, 1' left of centerline, up to 1122' MSL.

Trees, buildings, terrain, fence, tower, poles, general utility beginning 2628' from DER, 77' left of centerline, up to 1130' MSL.

Trees, pole, terrain, fence beginning 2927' from DER, 113' left of centerline, up to 1141' MSL.

Tree 3495' from DER, 459' right of centerline, up to 1125' MSL.

Trees beginning 3582' from DER, 366' right of centerline, up to 1134' MSL.

Trees beginning 3659' from DER, 652' right of centerline, up to 1140' MSL.

Trees beginning 3679' from DER, 117' right of centerline, up to 1141' MSL.

Trees, fence, terrain, beginning 3724' from DER, 218' left of centerline, up to 1147' MSL.

Trees, fence, terrain, buildings beginning 3819' from DER, 30' left of centerline, up to 1164' MSL.

Trees beginning 3838' from DER, 22' right of centerline, up to 1154' MSL.

Trees beginning 4029' from DER, abeam centerline, up to 1160' MSL.

Trees beginning 5636' from DER, 50' left of centerline, up to 1173' MSL.

Trees beginning 5721' from DER, 108' left of centerline, up to 1181' MSL.

Trees beginning 5832' from DER, 66' left of centerline, up to 1194' MSL.

Tree 6072' from DER, 522' left of centerline, 1171' MSL.

**Rwy 23**, vehicles on traverse way beginning 71' from DER, 343' left of centerline, 998' MSL.

Vehicles on traverse way beginning 114' from DER, 317' right of centerline, up to 1001' MSL.

Building 121' from DER, 456' left of centerline, 22' AGL/1003' MSL.

Building, vehicles on traverse way beginning 172' from DER, 229' left of centerline, up to 28' AGL/1012' MSL.

Trees, vehicles on traverse way, terrain beginning 245' from DER, 7' left of centerline, up to 1029' MSL.

Trees beginning 270' from DER, 374' right of centerline, up to 1002' MSL.

Trees beginning 497' from DER, 149' right of centerline, up to 1013' MSL.

Tree 631' from DER, 224' right of centerline, 1018' MSL.

Trees beginning 632' from DER, 78' right of centerline, up to 1023' MSL.

Trees, poles, terrain beginning 730' from DER, 74' right of centerline, up to 1053' MSL.

Terrain beginning 900' from DER, 10' left of centerline, up to 1031' MSL.

Tree 1331' from DER, 104' left of centerline, 1034' MSL.

Tree 1338' from DER, 18' left of centerline, 1036' MSL.

Trees beginning 1565' from DER, abeam centerline, up to 1061' MSL.

Tree 1623' from DER, 221' left of centerline, 1041' MSL.

Trees beginning 1682' from DER, 283' left of centerline, up to 1042' MSL.

Tree 1818' from DER, 367' left of centerline, 1053' MSL.

Trees beginning 1885' from DER, 2' left of centerline, up to 1065' MSL.

Trees beginning 2188' from DER, 629' left of centerline, up to 1067' MSL.

Trees beginning 2355' from DER, 621' left of centerline, up to 1072' MSL.

Trees beginning 2823' from DER, 37' left of centerline, up to 1082' MSL.

Trees beginning 3045' from DER, 35' left of centerline, up to 1092' MSL.

Trees beginning 3053' from DER, 89' right of centerline, up to 1084' MSL.

**ASHLAND, OH****ASHLAND COUNTY (3G4)****TAKEOFF MINIMUMS AND (OBSTACLE) DEPARTURE PROCEDURES**

AMDT 3 06MAY10 (10126) (FAA)

**TAKEOFF OBSTACLE NOTES:****Rwy 1**, trees beginning 61' from DER, 194' right of centerline, up to 50' AGL/1249' MSL.**Rwy 19**, trees beginning 5' from DER, 167' left of centerline, up to 50' AGL/1259' MSL.

**TAKEOFF MINIMUMS, (OBSTACLE) DEPARTURE PROCEDURES, AND**

  
**DIVERSE VECTOR AREA (RADAR VECTORS)**

24025

# TAKEOFF MINIMUMS, (OBSTACLE) DEPARTURE PROCEDURES, AND DIVERSE VECTOR AREA (RADAR VECTORS)

24025

## ASHTABULA, OH

NORTHEAST OHIO RGNL (HZY)

TAKEOFF MINIMUMS AND (OBSTACLE) DEPARTURE PROCEDURES

AMDT 1 12OCT17 (17285) (FAA)

TAKEOFF OBSTACLE NOTES:

**Rwy 9**, tree 492' from DER, 507' left of centerline, 23' AGL/942' MSL.

Tree 904' from DER, 708' left of centerline, 5' AGL/962' MSL.

Tree 1187' from DER, 650' left of centerline, 14' AGL/966' MSL.

Trees beginning 1259' from DER, 629' left of centerline, up to 40' AGL/967' MSL.

Tree 1370' from DER, 739' left of centerline, 76' AGL/995' MSL.

Trees beginning 1464' from DER, 619' left of centerline, up to 83' AGL/1002' MSL.

Trees beginning 1613' from DER, 699' left of centerline, up to 90' AGL/1010' MSL.

Trees beginning 1737' from DER, 575' left of centerline, up to 103' AGL/1023' MSL.

Trees beginning 1778' from DER, 468' left of centerline, up to 105' AGL/1026' MSL.

Tree 2099' from DER, 816' right of centerline, 49' AGL/981' MSL.

Tree 2139' from DER, 748' right of centerline, 73' AGL/999' MSL.

Trees beginning 2201' from DER, 169' right of centerline, up to 75' AGL/1003' MSL.

**Rwy 27**, trees beginning 746' from DER, 646' right of centerline, up to 45' AGL/939' MSL.

Pole 801' from DER, 484' left of centerline, 29' AGL/937' MSL.

Pole 818' from DER, 645' left of centerline, 35' AGL/938' MSL.

Trees beginning 1059' from DER, 678' right of centerline, up to 59' AGL/949' MSL.

Trees beginning 1134' from DER, 646' right of centerline, up to 84' AGL/978' MSL.

Trees beginning 1182' from DER, 740' left of centerline, up to 72' AGL/966' MSL.

Trees beginning 1978' from DER, 546' right of centerline, up to 92' AGL/991' MSL.

Tree 3418' from DER, 811' left of centerline, 97' AGL/995' MSL.

Tree 3717' from DER, 1073' left of centerline, 105' AGL/1003' MSL.

## ATHENS (ALBANY), OH

OHIO UNIVERSITY (UNI)

TAKEOFF MINIMUMS AND (OBSTACLE) DEPARTURE PROCEDURES

ORIG-A 23JUL15 (15204) (FAA)

TAKEOFF MINIMUMS:

**Rwy 7**, 200-1 or std. w/ min. climb of 310' per NM to 1000.

**Rwy 25**, 200-1 or std. w/ min. climb of 360' per NM to 1000.

TAKEOFF OBSTACLE NOTES:

**Rwy 7**, trees beginning 4439' from DER, 1034' left of centerline, up to 100' AGL/933' MSL.

Trees beginning 2869' from DER, 1171' right of centerline, up to 100' AGL/879' MSL.

Vehicle abeam DER 451' left of centerline, 17' AGL/769' MSL.

**Rwy 25**, trees beginning 3371' from DER, 425' left of centerline, up to 100' AGL/925' MSL.

Trees beginning 1221' from DER, 624' right of centerline, up to 100' AGL/999' MSL.

## AUBURN, IN

DE KALB COUNTY (GWB)

TAKEOFF MINIMUMS AND (OBSTACLE) DEPARTURE PROCEDURES

AMDT 1 28SEP06 (06271) (FAA)

TAKEOFF OBSTACLE NOTES:

**Rwy 9**, multiple trees beginning 428' from DER, 227' right of centerline, up to 100' AGL/979' MSL.

**Rwy 27**, multiple trees beginning 83' from DER, 207' left of centerline, up to 100' AGL/939' MSL.

Multiple tree beginning 1377' from DER, 316' right of centerline, up to 100' AGL/930' MSL.

## BARNESVILLE, OH

BARNESVILLE-BRADFIELD (6G5)

TAKEOFF MINIMUMS AND (OBSTACLE) DEPARTURE PROCEDURES

ORIG 24OCT85 (85297) (FAA)

TAKEOFF MINIMUMS:

**Rwys 9, 27**, 300-1.

22 FEB 2024 to 21 MAR 2024

22 FEB 2024 to 21 MAR 2024

# TAKEOFF MINIMUMS, (OBSTACLE) DEPARTURE PROCEDURES, AND DIVERSE VECTOR AREA (RADAR VECTORS)

24025



# TAKEOFF MINIMUMS, (OBSTACLE) DEPARTURE PROCEDURES, AND DIVERSE VECTOR AREA (RADAR VECTORS)

24025

## BATAVIA, OH

CLERMONT COUNTY (I69)

TAKEOFF MINIMUMS AND (OBSTACLE) DEPARTURE PROCEDURES

ORIG 03MAY12 (12124) (FAA)

TAKEOFF OBSTACLE NOTES:

**Rwy 4**, terrain 8' from DER, 311' left of centerline, 813' MSL.

Trees beginning 89' from DER, left and right of centerline, up to 100' AGL/899' MSL.

Fence 195' from DER, 276' left of centerline, up to 19' AGL/819' MSL.

Vehicles on roadway beginning 237' from DER, left and right of centerline, up to 15' AGL/824' MSL.

Windsock 408' from DER, 225' right of centerline, up to 24' AGL/824' MSL.

**Rwy 22**, buildings 55' from DER, left and right of centerline, up to 22' AGL/862' MSL.

Trees beginning 81' from DER, left and right of centerline, up to 100' AGL/ 967' MSL.

Fences beginning 102' from DER, left and right of centerline, up to 17' AGL/857' MSL.

Poles beginning 195' from DER, left and right of centerline, up to 45' AGL/ 885' MSL.

Vehicles on roadway beginning 216' from DER, left and right of centerline, up to 15' AGL/866' MSL.

Sign 441' from DER, 231' left of centerline, up to 19' AGL/859' MSL.

## BEDFORD, IN

VIRGIL I GRISSOM MUNI (BFR)

TAKEOFF MINIMUMS AND (OBSTACLE) DEPARTURE PROCEDURES

ORIG 22SEP11 (11265) (FAA)

TAKEOFF OBSTACLE NOTES:

**Rwy 6**, trees beginning 321' from DER, left and right of centerline, up to 112' AGL/830' MSL.

**Rwy 13**, trees beginning 78' from DER, left and right of centerline, up to 110' AGL/849' MSL.

**Rwy 24**, trees beginning 534' from DER, left and right of centerline, up to 100' AGL/800' MSL.

**Rwy 31**, trees beginning 27' from DER, left and right of centerline, up to 107' AGL/806' MSL.

## BELLEFONTAINE, OH

BELLEFONTAINE RGNL (EDJ)

TAKEOFF MINIMUMS AND (OBSTACLE) DEPARTURE PROCEDURES

ORIG-A 18OCT12 (12292) (FAA)

TAKEOFF MINIMUMS:

**Rwy 7**, std. w/min. climb of 245' per NM to 2100.

DEPARTURE PROCEDURE:

**Rwy 7**, climb heading 074° to 2100 before proceeding on course.

TAKEOFF OBSTACLE NOTES:

**Rwy 7**, trees beginning 2172' from DER, 43' right of centerline, up to 99' AGL/ 1224' MSL.

Trees beginning 2252' from DER, 77' left of centerline, up to 89' AGL/1228' MSL.

**Rwy 25**, tree 508' from DER, 539' right of centerline, 35' AGL/ 1144' MSL.

Ground 66' from DER, 494' right of centerline, 1107' MSL.

## BLOOMINGTON, IN

MONROE COUNTY (BMG)

TAKEOFF MINIMUMS AND (OBSTACLE) DEPARTURE PROCEDURES

AMDT 6 25AUG11 (11237) (FAA)

TAKEOFF MINIMUMS:

**Rwy 24**, 300-1.

TAKEOFF OBSTACLE NOTES:

**Rwy 6**, poles and building beginning 424' from DER, 332' left of centerline, up to 29' AGL/874' MSL.

Trees beginning 491' from DER, left and right of centerline, up to 72' AGL/972' MSL.

Fence 181' from DER, 115' right of centerline, 6' AGL/846' MSL.

Vehicle on road beginning 89' from DER, left and right of centerline, 15' AGL/862' MSL.

**Rwy 17**, vehicle on road 187' from DER, 18' right of centerline, 15' AGL/850' MSL.

Tree 1263' from DER, 625' right of centerline, 32' AGL/871' MSL.

Bush 855' from DER, 594' left of centerline, 25' AGL/862' MSL.

**Rwy 24**, trees and poles beginning 158' from DER, left and right of centerline, up to 85' AGL/1021' MSL.

Fence 394' from DER, 72' left of centerline, 9' AGL/849' MSL.

Buildings beginning 1990' from DER, 321' right of centerline, up to 25' AGL/952' MSL.

Vehicle on road beginning 45' from DER, left and right of centerline, 15' AGL/945' MSL.

**Rwy 35**, trees beginning 2119' from DER, 120' left and right of centerline, up to 85' AGL/975' MSL.

22 FEB 2024 to 21 MAR 2024

22 FEB 2024 to 21 MAR 2024

# TAKEOFF MINIMUMS, (OBSTACLE) DEPARTURE PROCEDURES, AND DIVERSE VECTOR AREA (RADAR VECTORS)

24025

# TAKEOFF MINIMUMS, (OBSTACLE) DEPARTURE PROCEDURES, AND DIVERSE VECTOR AREA (RADAR VECTORS)

24025

## BLUFFTON, OH

### BLUFFTON (5G7)

#### TAKEOFF MINIMUMS AND (OBSTACLE) DEPARTURE PROCEDURES

AMDT 1A 15OCT15 (15288) (FAA)

##### TAKEOFF OBSTACLE NOTES:

**Rwy 5**, runway lights beginning 9' from DER, left and right of centerline, up to 3' AGL/848' MSL.  
Road and pole beginning 53' from DER, left and right of centerline, up to 42' AGL/889' MSL.  
Roads beginning 211' from DER, 330' right of centerline, up to 17' AGL/881' MSL.  
Poles, road and tree beginning 497' from DER, up to 100' AGL/883' MSL.  
Trees and poles beginning 1205' from DER, left and right of centerline, up to 100' AGL/911' MSL.  
**Rwy 23**, runway lights beginning 8' from DER, left and right of centerline, up to 4' AGL/852' MSL.  
Trees beginning 1205' from DER, 167' left of centerline, 100' AGL/853' MSL.  
Tree 298' from DER, 506' right of centerline, 100' AGL/866' MSL.  
Trees beginning 405 from DER, left and right of centerline, up to 100' AGL/900' MSL.  
Trees beginning 1007' from DER, left and right of centerline, up to 100' AGL/932' MSL.

## BOWLING GREEN, OH

### WOOD COUNTY (1G0)

#### TAKEOFF MINIMUMS AND (OBSTACLE) DEPARTURE PROCEDURES

AMDT 3 15MAR07 (07074) (FAA)

##### TAKEOFF MINIMUMS:

**Rwy 18**, 300-1.

##### TAKEOFF OBSTACLE NOTES:

**Rwy 18**, building/tower 3581' from DER, 254' right of centerline, 141' AGL/841' MSL.

## BRAZIL, IN

### BRAZIL CLAY COUNTY (0I2)

#### TAKEOFF MINIMUMS AND (OBSTACLE) DEPARTURE PROCEDURES

##### TAKEOFF MINIMUMS:

**Rwys 9, 27**, 300-1.

## BRYAN, OH

### WILLIAMS COUNTY (0G6)

#### TAKEOFF MINIMUMS AND (OBSTACLE) DEPARTURE PROCEDURES

ORIG 03JUN10 (10154) (FAA)

##### TAKEOFF OBSTACLE NOTES:

**Rwy 7**, vehicles on road beginning 49' from DER, from left to right of centerline, up to 15' AGL/734' MSL.  
Tree 160' from DER, 323' left of centerline 30' AGL/759' MSL.  
Trees beginning 324' from DER, 403' right of centerline, up to 101' AGL/829' MSL.  
**Rwy 25**, vehicles on road beginning 203' from DER, from right to left of centerline, up to 15' AGL/744' MSL.  
Pole 285' from DER, 329' right of centerline, 37' AGL/767' MSL.  
Trees beginning 2787' from DER, 769' right of centerline, up to 100' AGL/829' MSL.

## BUCYRUS, OH

### PORT BUCYRUS/CRAWFORD COUNTY (17G)

#### TAKEOFF MINIMUMS AND (OBSTACLE) DEPARTURE PROCEDURES

AMDT 2 18NOV10 (22195) (FAA)

##### TAKEOFF MINIMUMS:

**Rwy 4**, 300-1½ or std. w/ min. climb of 297' per NM to 1300, or alternatively, with std. takeoff minimums and a normal 200' per NM climb gradient, takeoff must occur no later than 1400' prior to DER.

##### TAKEOFF OBSTACLE NOTES:

**Rwy 4**, terrain 4' from DER, 484' right of centerline, up to 1008' MSL.  
Aircraft on ramp beginning 47' from DER, 289' right of centerline, up to 15' AGL/1019' MSL.  
Terrain beginning 93' from DER, 245' left of centerline, up to 1008' MSL.  
Vehicle on road beginning 107' from DER, 487' right of centerline, 15' AGL/1019' MSL.  
Trees 229' from DER, 261' left of centerline, up to 100' AGL/1099' MSL.  
Trees 2777' from DER, 1207' left of centerline, up to 100' AGL/1109' MSL.  
Trees 2933' from DER, 330' right of centerline, up to 100' AGL/1124' MSL.  
Tower 1.1 NM from DER, 1798' left of centerline, 165' AGL/1175' MSL.  
**Rwy 22**, buildings beginning 4' from DER, 352' right of centerline, up to 40' AGL/1044' MSL.  
Vehicle on road beginning 243' from DER, 552' left of centerline, 15' AGL/1019' MSL.  
Trees 426' from DER, 382' left of centerline, up to 100' AGL/1104' MSL.  
Trees 733' from DER, 466' right of centerline, up to 100' AGL/1099' MSL.

22 FEB 2024 to 21 MAR 2024

22 FEB 2024 to 21 MAR 2024

# TAKEOFF MINIMUMS, (OBSTACLE) DEPARTURE PROCEDURES, AND DIVERSE VECTOR AREA (RADAR VECTORS)

24025

EC-2

# TAKEOFF MINIMUMS, (OBSTACLE) DEPARTURE PROCEDURES, AND DIVERSE VECTOR AREA (RADAR VECTORS)

24025

## CADIZ, OH

### HARRISON COUNTY (8G6)

#### TAKEOFF MINIMUMS AND (OBSTACLE) DEPARTURE PROCEDURES

AMDT 4 10SEP20 (20254) (FAA)

##### TAKEOFF MINIMUMS:

**Rwy 13**, 300-1/4 or std. w/min. climb of 274' per NM to 1400.

##### TAKEOFF OBSTACLE NOTES:

**Rwy 13**, tree, vegetation beginning 31' from DER, 98' left of centerline, up to 1133' MSL.  
 Building, tree beginning 55' from DER, 163' right of centerline, up to 17' AGL/1127' MSL.  
 Pole, tree beginning 190' from DER, 114' left of centerline, up to 39' AGL/1148' MSL.  
 Trees beginning 225' from DER, 154' right of centerline, up to 1132' MSL.  
 Tree, pole beginning 407' from DER, 82' left of centerline, up to 1175' MSL.  
 Tree 656' from DER, 449' right of centerline, 1137' MSL.  
 Tree 697' from DER, 281' right of centerline, 1139' MSL.  
 Tree 722' from DER, 647' right of centerline, 1144' MSL.  
 Tree 811' from DER, 450' right of centerline, 1156' MSL.  
 Trees beginning 858' from DER, 179' right of centerline, up to 1158' MSL.  
 Trees beginning 927' from DER, 58' right of centerline, up to 1169' MSL.  
 Tree, terrain, pole, fence beginning 1068' from DER, 44' right of centerline, up to 1199' MSL.  
 Tree 1530' from DER, 151' left of centerline, 1195' MSL.  
 Trees beginning 1620' from DER, 221' left of centerline, up to 1204' MSL.  
 Trees beginning 1727' from DER, 4' left of centerline, up to 1215' MSL.  
 Terrain, tree beginning 1927' from DER, 22' right of centerline, up to 1208' MSL.  
 Trees beginning 2703' from DER, 87' left of centerline, up to 1220' MSL.  
 Tree, terrain beginning 2811' from DER, 228' right of centerline, up to 1224' MSL.  
 Tree, terrain beginning 2944' from DER, 68' right of centerline, up to 1230' MSL.  
 Tree 3047' from DER, 126' left of centerline, 1222' MSL.  
 Tree, terrain beginning 3080' from DER, 43' right of centerline, up to 1232' MSL.  
 Trees beginning 3277' from DER, 401' right of centerline, up to 1233' MSL.  
 Trees beginning 3399' from DER, 104' right of centerline, up to 1234' MSL.  
 Tree 5966' from DER, 2009' right of centerline, 1273' MSL.  
 Tree 1 NM from DER, 2037' right of centerline, 1309' MSL.  
 Trees beginning 1 NM from DER, 1544' right of centerline, up to 1325' MSL.  
 Tree 1.3 NM from DER, 428' left of centerline, 1312' MSL.  
 Trees beginning 1.3 NM from DER, 343' left of centerline, up to 1329' MSL.  
 Trees beginning 1.4 NM from DER, 1568' left of centerline, up to 1339' MSL.  
 Tree 1.4 NM from DER, 1705' left of centerline, 1340' MSL.  
 Trees beginning 1.5 NM from DER, 1653' left of centerline, up to 1350' MSL.  
 Trees beginning 1.5 NM from DER, 1592' left of centerline, up to 1350' MSL.  
**Rwy 31**, terrain 40' from DER, 175' right of centerline, 1198' MSL.  
 Terrain 71' from DER, 374' left of centerline, 1188' MSL.  
 Terrain 89' from DER, 287' right of centerline, 1219' MSL.  
 Terrain 99' from DER, 195' left of centerline, 1194' MSL.  
 Trees and fence beginning 136' from DER, 5' right of centerline, up to 1229' MSL.  
 Terrain 196' from DER, 494' left of centerline, 1213' MSL.  
 Trees beginning 204' from DER, 200' left of centerline, up to 1214' MSL.  
 Fence beginning 341' from DER, 97' left of centerline, up to 3' AGL/1218' MSL.  
 Trees and fence beginning 403' from DER, 1' right of centerline, up to 1235' MSL.  
 Fence beginning 485' from DER, 100' left of centerline, up to 4' AGL/1219' MSL.  
 Fence beginning 802' from DER, 109' left of centerline, up to 4' AGL/1224' MSL.  
 Fence and vegetation beginning 964' from DER, 41' left of centerline, up to 4' AGL/1226' MSL.  
 Trees and fence beginning 991' from DER, 88' left of centerline, up to 1229' MSL.

## CALDWELL, OH

### NOBLE COUNTY (I10)

#### TAKEOFF MINIMUMS AND (OBSTACLE) DEPARTURE PROCEDURES

AMDT 1 22MAY97 (97146) (FAA)

##### TAKEOFF MINIMUMS:

**Rwy 5, 23**, 400-1.

##### DEPARTURE PROCEDURE:

**Rwy 23**, climb runway heading to 1500 before turning.

22 FEB 2024 to 21 MAR 2024

22 FEB 2024 to 21 MAR 2024

# TAKEOFF MINIMUMS, (OBSTACLE) DEPARTURE PROCEDURES, AND DIVERSE VECTOR AREA (RADAR VECTORS)

24025

EC-2

# TAKEOFF MINIMUMS, (OBSTACLE) DEPARTURE PROCEDURES, AND DIVERSE VECTOR AREA (RADAR VECTORS)

24025

## CAMBRIDGE, OH

### CAMBRIDGE MUNI (CDI)

#### TAKEOFF MINIMUMS AND (OBSTACLE) DEPARTURE PROCEDURES

AMDT 3 05MAR15 (15064) (FAA)

##### TAKEOFF MINIMUMS:

**Rwy 4**, 400-2 or std. w/min. climb of 397' per NM to 1400.

**Rwy 22**, 300-1½ or std. w/min. climb of 685' per NM to 1100.

##### DEPARTURE PROCEDURE:

**Rwy 4**, climb heading 040° to 1300 before turning left.

##### TAKEOFF OBSTACLE NOTES:

**Rwy 4**, multiple trees beginning 161' from DER, 179' left of centerline, up to 51' AGL/849' MSL.

Multiple trees beginning 672' from DER, 563' right of centerline, up to 62' AGL/860' MSL.

Multiple poles beginning 301' from DER, 519' right of centerline, up to 31' AGL/973' MSL.

Multiple towers beginning 794' from DER, 659' left of centerline, up to 43' AGL/835' MSL.

Building 639' from DER, 386' right of centerline, 25' AGL/825' MSL.

Multiple poles beginning 990' from DER, 26' left of centerline, up to 36' AGL/826' MSL.

Multiple trees beginning 1147' from DER, 144' right of centerline, up to 74' AGL/872' MSL.

Multiple trees beginning 1307' from DER, 2' left of centerline, up to 89' AGL/887' MSL.

Multiple towers, poles beginning 1040' from DER, 336' right of centerline, up to 48' AGL/843' MSL.

Multiple towers, poles beginning 1089' from DER, 613' left of centerline, up to 36' AGL/833' MSL.

Sign 1029' from DER, 623' left of centerline, 35' AGL/832' MSL.

Monument 1.5 NM from DER, 402' left of centerline, 120' AGL/1098' MSL.

Multiple trees beginning 1.5 NM from DER, 738' right of centerline, up to 100' AGL/1126' MSL.

Tower 2.8 NM from DER, 4400' left of centerline, 233' AGL/1106' MSL.

**Rwy 22**, multiple trees beginning 204' from DER, 309' right of centerline, up to 100' AGL/931' MSL.

Multiple poles beginning 366' from DER, 43' right of centerline, up to 35' AGL/834' MSL.

NAVAID 300' from DER, 1' right of centerline, 9' AGL/807' MSL.

Obstruction light on DME 477' from DER, 168' right of centerline, 19' AGL/817' MSL.

Multiple trees beginning 1004' from DER, 395' left of centerline, up to 100' AGL/1023' MSL.

Multiple poles beginning 1165' from DER, 93' left of centerline, up to 34' AGL/1021' MSL.

Building 1272' from DER, 426' right of centerline, 21' AGL/881' MSL.

## CARROLLTON, OH

### CARROLL COUNTY-TOLSON (TSO)

#### TAKEOFF MINIMUMS AND (OBSTACLE) DEPARTURE PROCEDURES

AMDT 5 02DEC21 (21336) (FAA)

##### TAKEOFF MINIMUMS:

**Rwy 7**, 400-2½ or std. w/min. climb of 611' per NM to 1400.

##### TAKEOFF OBSTACLE NOTES:

**Rwy 7**, trees, poles beginning 28' from DER, 8' left of centerline, up to 82' AGL/1232' MSL.

Trees beginning 343' from DER, 177' right of centerline, up to 65' AGL/1187' MSL.

Trees beginning 403' from DER, 117' right of centerline, up to 1195' MSL.

Tree 613' from DER, 205' right of centerline, 77' AGL/1203' MSL.

Trees beginning 625' from DER, 54' right of centerline, up to 1212' MSL.

Trees, building beginning 1511' from DER, 502' left of centerline, up to 1246' MSL.

Trees beginning 1549' from DER, 538' right of centerline, up to 1223' MSL.

Trees beginning 1566' from DER, 5' left of centerline, up to 1248' MSL.

Tree 1666' from DER, 612' left of centerline, 1270' MSL.

Trees beginning 1671' from DER, 38' left of centerline, up to 1299' MSL.

Trees beginning 1779' from DER, 25' right of centerline, up to 70' AGL/1253' MSL.

Trees beginning 1836' from DER, 28' left of centerline, up to 1311' MSL.

Trees beginning 1926' from DER, 41' left of centerline, up to 1312' MSL.

Trees beginning 1961' from DER, 60' right of centerline, up to 69' AGL/1264' MSL.

Tree 2003' from DER, 246' right of centerline, 70' AGL/1271' MSL.

Trees beginning 2014' from DER, 133' right of centerline, up to 81' AGL/1279' MSL.

Trees beginning 2035' from DER, 2' right of centerline, up to 108' AGL/1300' MSL.

Trees beginning 2075' from DER, 22' left of centerline, up to 77' AGL/1322' MSL.

Trees beginning 2183' from DER, 53' left of centerline, up to 88' AGL/1323' MSL.

Trees beginning 2383' from DER, 6' left of centerline, up to 119' AGL/1325' MSL.

Trees beginning 2545' from DER, 101' left of centerline, up to 114' AGL/1333' MSL.

Trees beginning 2606' from DER, 181' left of centerline, up to 71' AGL/1334' MSL.

Trees beginning 2706' from DER, 291' left of centerline, up to 76' AGL/1342' MSL.

Trees, transmission line beginning 3135' from DER, 25' left of centerline, up to 1344' MSL.

Tree 1.1 NM from DER, 1828' right of centerline, 91' AGL/1355' MSL.

Transmission line 2 NM from DER, 823' right of centerline, 118' AGL/1479' MSL.

**Rwy 25**, tree 47' from DER, 240' left of centerline, 1183' MSL.

Terrain 119' from DER, 521' left of centerline, 1184' MSL.

Trees beginning 129' from DER, 253' left of centerline, up to 9' AGL/1191' MSL.

Trees beginning 213' from DER, 245' left of centerline, up to 1199' MSL.

Trees beginning 595' from DER, 322' left of centerline, up to 1205' MSL.

Trees beginning 880' from DER, 677' left of centerline, up to 1236' MSL.

Transmission line 5230' from DER, 1788' left of centerline, 1306' MSL.

22 FEB 2024 to 21 MAR 2024

22 FEB 2024 to 21 MAR 2024

# TAKEOFF MINIMUMS, (OBSTACLE) DEPARTURE PROCEDURES, AND DIVERSE VECTOR AREA (RADAR VECTORS)

24025

EC-2

# TAKEOFF MINIMUMS, (OBSTACLE) DEPARTURE PROCEDURES, AND DIVERSE VECTOR AREA (RADAR VECTORS)

24025

## CELINA, OH

### LAKEFIELD (CQA)

#### TAKEOFF MINIMUMS AND (OBSTACLE) DEPARTURE PROCEDURES

AMDT 2 11FEB10 (10042) (FAA)

##### TAKEOFF OBSTACLE NOTES:

**Rwy 8**, trees beginning 782' from DER, 7' right of centerline, up to 100' AGL/969' MSL.

Trees beginning 57' from DER, 130' left of centerline, up to 100' AGL/976' MSL.

**Rwy 26**, vehicle 63' from DER, 469' right of centerline, 15' AGL/909' MSL.

Poles beginning 127' from DER, 145' right of centerline, up to 51' AGL/941' MSL.

Antenna 653' from DER, 498' right of centerline, 33' AGL/923' MSL.

Trees beginning 1194' from DER, 319' right of centerline, up to 100' AGL/952' MSL.

## CHILLICOTHE, OH

### ROSS COUNTY (RZT)

#### TAKEOFF MINIMUMS AND (OBSTACLE) DEPARTURE PROCEDURES

AMDT 3A 17NOV11 (11321) (FAA)

##### TAKEOFF MINIMUMS:

**Rwy 23**, 400-1 or std. with min. climb of 340' per NM to 1300.

##### DEPARTURE PROCEDURE:

**Rwy 5**, climb runway heading to 1500 before turning right.

**Rwy 23**, climb runway heading to 1500 before turning left.

## CINCINNATI, OH

### CINCINNATI MUNI/LUNKEN FLD (LUK)

#### TAKEOFF MINIMUMS AND (OBSTACLE) DEPARTURE PROCEDURES

AMDT 15 15AUG19 (21112) (FAA)

##### TAKEOFF MINIMUMS:

**Rwy 3L**, 400-2 w/min. climb of 226' per NM to 1300 or std. w/min. climb of 423' per NM to 1000 or 1700-3 for VCOA.

**Rwy 3R**, 400-2 w/min. climb of 233' per NM to 1300 or std. w/min. climb of 384' per NM to 1100 or 1700-3 for VCOA.

**Rwy 7**, 400-1½ w/min. climb of 279' per NM to 1000 or std. w/min. climb of 451' per NM to 1000 or 1700-3 for VCOA.

**Rwy 21L**, 500-2½ w/min. climb of 254' per NM to 1100 or std. w/min. climb of 439' per NM to 1000 or 1700-3 for VCOA.

**Rwy 21R**, 500-2¾ w/min. climb of 226' per NM to 1100 or std. w/min. climb of 489' per NM to 1100 or 1700-3 for VCOA.

**Rwy 25**, 600-2½ w/min. climb of 268' per NM to 1100 or 1700-3 for VCOA.

##### DEPARTURE PROCEDURE:

**Rwy 3L**, climb heading 027° to 1200 before proceeding on course.

**Rwy 3R**, climb heading 025° to 1400 before proceeding on course.

**Rwy 7**, climb heading 066° to 1300 before proceeding on course.

**Rwy 21L**, climb heading 205° to 1400 before proceeding on course.

**Rwy 21R**, climb heading 207° to 1500 before proceeding on course.

**Rwy 25**, climb heading 246° to 1900 before proceeding on course.

##### VCOA:

Obtain ATC approval for VCOA when requesting IFR clearance. Climb in visual conditions to cross Cincinnati Muni/Lunken Fld at or above 2000 before proceeding on course.

##### TAKEOFF OBSTACLE NOTES:

**Rwy 3L**, buildings beginning 108' from DER, 259' left of centerline, up to 514' MSL.

Pole 510' from DER, 595' right of centerline, 501' MSL.

Buildings beginning 609' from DER, 308' left of centerline, up to 41' AGL/520' MSL.

Buildings, trees beginning 660' from DER, 428' right of centerline, up to 63' AGL/542' MSL.

Tree 1145' from DER, 319' left of centerline, 545' MSL.

Tree 1561' from DER, 734' right of centerline, 543' MSL.

Tree 1710' from DER, 653' left of centerline, 566' MSL.

Trees beginning 1786' from DER, 270' right of centerline, up to 545' MSL.

Building, elevator, trees beginning 2808' from DER, 435' left of centerline, up to 612' MSL.

Trees beginning 3597' from DER, 862' right of centerline, up to 574' MSL.

Trees beginning 3788' from DER, 402' right of centerline, up to 585' MSL.

Stack 5180' from DER, 1104' left of centerline, 634' MSL.

Tree 5305' from DER, 1642' left of centerline, 737' MSL.

Tree 6007' from DER, 1547' left of centerline, 740' MSL.

Trees beginning 1 NM from DER, 1604' left of centerline, up to 814' MSL.

Trees, buildings, terrain beginning 1.1 NM from DER, 583' left of centerline, up to 850' MSL.

Trees beginning 1.2 NM from DER, 598' left of centerline, up to 856' MSL.

Trees, building, terrain beginning 1.2 NM from DER, 413' left of centerline, up to 864' MSL.

Trees, terrain beginning 1.3 NM from DER, 301' left of centerline, up to 869' MSL.

Trees, terrain, poles, building beginning 1.4 NM from DER, 112' left of centerline, up to 875' MSL.

Tree 1.7 NM from DER, 734' left of centerline, 108' AGL/775' MSL.

**Rwy 3R**, terrain 30' from DER, 476' left of centerline, 476' MSL.

Trees beginning 513' from DER, 335' right of centerline, up to 521' MSL.

Trees beginning 913' from DER, 579' left of centerline, up to 508' MSL.

Trees beginning 1084' from DER, 185' left of centerline, up to 527' MSL.

Trees beginning 1573' from DER, 128' right of centerline, up to 50' AGL/524' MSL.

Trees beginning 1662' from DER, 177' left of centerline, up to 529' MSL.

Trees beginning 1885' from DER, 285' right of centerline, up to 531' MSL.

Tree 1969' from DER, 501' right of centerline, 532' MSL.

CON'T

# TAKEOFF MINIMUMS, (OBSTACLE) DEPARTURE PROCEDURES, AND DIVERSE VECTOR AREA (RADAR VECTORS)

24025

EC-2

**TAKEOFF MINIMUMS, (OBSTACLE) DEPARTURE PROCEDURES, AND**

  
**DIVERSE VECTOR AREA (RADAR VECTORS)**

24025

**CINCINNATI, OH (CON'T)****CINCINNATI MUNI/LUNKEN FLD (LUK) (CON'T)****Rwy 3R (CON'T)**, tree 2015' from DER, 979' right of centerline, 58' AGL/533' MSL.

Trees beginning 2058' from DER, 385' right of centerline, up to 539' MSL.

Trees beginning 2437' from DER, 896' right of centerline, up to 549' MSL.

Tree 2448' from DER, 749' left of centerline, 538' MSL.

Trees beginning 2621' from DER, 587' right of centerline, up to 551' MSL.

Tree 2641' from DER, 1000' left of centerline, 543' MSL.

Trees beginning 2649' from DER, 424' right of centerline, up to 558' MSL.

Trees beginning 2698' from DER, 196' right of centerline, up to 572' MSL.

Trees beginning 2814' from DER, 98' right of centerline, up to 574' MSL.

Trees beginning 2833' from DER, 984' left of centerline, up to 553' MSL.

Tree 2914' from DER, 316' left of centerline, 556' MSL.

Trees beginning 2954' from DER, 439' left of centerline, up to 561' MSL.

Trees beginning 3128' from DER, 730' left of centerline, up to 574' MSL.

Trees beginning 3336' from DER, 167' left of centerline, up to 585' MSL.

Trees beginning 3363' from DER, 537' right of centerline, up to 576' MSL.

Trees beginning 3596' from DER, 627' right of centerline, up to 578' MSL.

Trees beginning 3695' from DER, 589' right of centerline, up to 579' MSL.

Trees beginning 3843' from DER, 730' right of centerline, up to 103' AGL/584' MSL.

Trees beginning 1.1 NM from DER, 2296' left of centerline, up to 695' MSL.

Trees beginning 1.1 NM from DER, 2295' left of centerline, up to 709' MSL.

Trees, terrain beginning 1.2 NM from DER, 2302' left of centerline, up to 717' MSL.

Trees beginning 1.2 NM from DER, 2223' left of centerline, up to 730' MSL.

Trees beginning 1.2 NM from DER, 2272' left of centerline, up to 759' MSL.

Trees beginning 1.2 NM from DER, 2192' left of centerline, up to 807' MSL.

Trees beginning 1.3 NM from DER, 2162' left of centerline, up to 851' MSL.

Trees beginning 1.3 NM from DER, 2070' left of centerline, up to 855' MSL.

Trees, building, poles beginning 1.3 NM from DER, 1811' left of centerline, up to 70' AGL/875' MSL.

Tree 1.6 NM from DER, 2442' left of centerline, 108' AGL/775' MSL.

**Rwy 7**, lighting 10' from DER, 59' right of centerline, 2' AGL/476' MSL.

Building 246' from DER, 554' left of centerline, 486' MSL.

Tree 530' from DER, 567' left of centerline, 26' AGL/498' MSL.

Trees beginning 706' from DER, 423' right of centerline, up to 521' MSL.

Trees beginning 946' from DER, 82' right of centerline, up to 538' MSL.

Tree 1155' from DER, 559' left of centerline, 33' AGL/505' MSL.

Trees beginning 1190' from DER, 84' left of centerline, up to 48' AGL/521' MSL.

Trees beginning 1512' from DER, 265' left of centerline, up to 50' AGL/524' MSL.

Trees beginning 1576' from DER, 30' left of centerline, up to 58' AGL/530' MSL.

Trees beginning 1718' from DER, 260' left of centerline, up to 532' MSL.

Trees beginning 1806' from DER, 316' left of centerline, up to 537' MSL.

Trees beginning 1810' from DER, 115' right of centerline, up to 550' MSL.

Trees beginning 2033' from DER, 300' left of centerline, up to 539' MSL.

Trees beginning 2116' from DER, 266' right of centerline, up to 77' AGL/551' MSL.

Trees beginning 2172' from DER, 21' right of centerline, up to 575' MSL.

Trees beginning 2272' from DER, 680' left of centerline, up to 545' MSL.

Tree 2425' from DER, 532' left of centerline, 549' MSL.

Trees beginning 2451' from DER, 729' left of centerline, up to 556' MSL.

Trees beginning 2499' from DER, 16' left of centerline, up to 572' MSL.

Trees beginning 2769' from DER, 16' left of centerline, up to 574' MSL.

Trees beginning 2879' from DER, on and right of centerline, up to 592' MSL.

**Rwy 7**, trees beginning 3002' from DER, 141' left of centerline, up to 100' AGL/576' MSL.

Trees beginning 3723' from DER, 1369' right of centerline, up to 668' MSL.

Trees, building, terrain beginning 3889' from DER, 1033' right of centerline, up to 694' MSL.

Trees beginning 4531' from DER, 1354' right of centerline, up to 709' MSL.

Trees beginning 4546' from DER, 1087' right of centerline, up to 731' MSL.

Trees beginning 1.1 NM from DER, 1899' right of centerline, up to 737' MSL.

Trees beginning 1.2 NM from DER, 1333' right of centerline, up to 757' MSL.

Trees beginning 1.2 NM from DER, 1427' right of centerline, up to 780' MSL.

Trees beginning 1.2 NM from DER, 1131' right of centerline, up to 782' MSL.

Tree, buildings beginning 1.2 NM from DER, 1224' right of centerline, up to 813' MSL.

Trees beginning 1.3 NM from DER, 1653' right of centerline, up to 79' AGL/823' MSL.

Tree 1.6 NM from DER, 2999' right of centerline, 759' MSL.

**Rwy 21L**, tree 90' from DER, 436' right of centerline, 7' AGL/486' MSL.

Trees beginning 437' from DER, 602' left of centerline, up to 509' MSL.

Tree 748' from DER, 605' left of centerline, 511' MSL.

Trees beginning 835' from DER, 587' left of centerline, up to 522' MSL.

Trees beginning 945' from DER, 583' left of centerline, up to 531' MSL.

Trees beginning 1288' from DER, 720' left of centerline, up to 535' MSL.

Tree 1510' from DER, 880' right of centerline, 524' MSL.

Tree 1553' from DER, 747' right of centerline, 525' MSL.

Trees beginning 1590' from DER, 648' right of centerline, up to 527' MSL.

Trees beginning 1597' from DER, 635' left of centerline, up to 570' MSL.

Trees beginning 1693' from DER, 218' right of centerline, up to 543' MSL.

Trees beginning 1770' from DER, 576' left of centerline, up to 573' MSL.

**CON'T**

**TAKEOFF MINIMUMS, (OBSTACLE) DEPARTURE PROCEDURES, AND**

  
**DIVERSE VECTOR AREA (RADAR VECTORS)**

24025

# TAKEOFF MINIMUMS, (OBSTACLE) DEPARTURE PROCEDURES, AND DIVERSE VECTOR AREA (RADAR VECTORS)

24025

## CINCINNATI, OH (CON'T)

### CINCINNATI MUNI/LUNKEN FLD (LUK) (CON'T)

**Rwy 21L (CON'T)**, trees beginning 1962' from DER, 173' left of centerline, up to 575' MSL.  
 Tree 2236' from DER, 372' right of centerline, 546' MSL.  
 Tree 2246' from DER, 250' right of centerline, 66' AGL/547' MSL.  
 Trees beginning 2347' from DER, 424' right of centerline, up to 549' MSL.  
 Trees beginning 2529' from DER, 6' left of centerline, up to 588' MSL.  
 Tree 2538' from DER, 600' right of centerline, 550' MSL.  
 Trees beginning 2601' from DER, 725' right of centerline, up to 556' MSL.  
 Tree 2923' from DER, 84' right of centerline, 96' AGL/575' MSL.  
 Trees beginning 3044' from DER, 3' right of centerline, up to 104' AGL/580' MSL.  
 Tree 3254' from DER, 328' right of centerline, 105' AGL/582' MSL.  
 Trees beginning 3344' from DER, 285' right of centerline, up to 106' AGL/584' MSL.  
 Trees beginning 3470' from DER, 42' right of centerline, up to 115' AGL/591' MSL.  
 Trees beginning 3614' from DER, 7' right of centerline, up to 135' AGL/597' MSL.  
 Tree 3868' from DER, 39' left of centerline, 129' AGL/589' MSL.  
 Trees beginning 3920' from DER, 111' left of centerline, up to 617' MSL.  
 Trees beginning 4007' from DER, 1406' left of centerline, up to 634' MSL.  
 Trees beginning 4102' from DER, 1321' left of centerline, up to 654' MSL.  
 Trees beginning 4376' from DER, 1254' left of centerline, up to 713' MSL.  
 Trees beginning 4614' from DER, 1152' left of centerline, up to 734' MSL.  
 Tree 1.4 NM from DER, 2928' right of centerline, 743' MSL.  
 Trees beginning 1.5 NM from DER, 2353' right of centerline, up to 755' MSL.  
 Trees beginning 1.5 NM from DER, 2334' right of centerline, up to 790' MSL.  
 Tree 1.5 NM from DER, 3033' right of centerline, 801' MSL.  
 Trees beginning 1.5 NM from DER, 2239' right of centerline, up to 807' MSL.  
 Trees beginning 1.5 NM from DER, 2457' right of centerline, up to 876' MSL.  
 Trees, terrain beginning 1.6 NM from DER, 2189' right of centerline, up to 882' MSL.  
 Trees beginning 1.6 NM from DER, 2241' right of centerline, up to 888' MSL.  
 Tree, pole beginning 1.6 NM from DER, 1845' right of centerline, up to 890' MSL.  
 Spires, building, tree beginning 1.9 NM from DER, 1589' right of centerline, up to 78' AGL/891' MSL.  
 Tower 2 NM from DER, 2018' right of centerline, 156' AGL/971' MSL.  
 Antennas, trees, tower, pole beginning 2 NM from DER, 259' right of centerline, up to 160' AGL/978' MSL.  
 Trees beginning 2.5 NM from DER, 849' right of centerline, up to 897' MSL.  
**Rwy 21R**, tree 990' from DER, 410' right of centerline, 576' MSL.  
 Tree 1315' from DER, 118' right of centerline, 581' MSL.  
 Tree 1428' from DER, 13' left of centerline, 563' MSL.  
 Trees beginning 1677' from DER, 181' left of centerline, up to 582' MSL.  
 Trees beginning 1945' from DER, 311' right of centerline, up to 595' MSL.  
 Tree 1.1 NM from DER, 1738' right of centerline, 716' MSL.  
 Trees beginning 1.1 NM from DER, 1751' right of centerline, up to 910' MSL.  
 Trees beginning 1.3 NM from DER, 990' right of centerline, up to 935' MSL.  
 Trees beginning 1.6 NM from DER, 2334' right of centerline, up to 941' MSL.  
 Trees, terrain, buildings, pole beginning 1.7 NM from DER, 2' right of centerline, up to 943' MSL.  
 Tree 1.8 NM from DER, 2' left of centerline, 789' MSL.  
 Trees beginning 1.9 NM from DER, 21' left of centerline, up to 808' MSL.  
 Trees beginning 1.9 NM from DER, 101' left of centerline, up to 817' MSL.  
 Trees beginning 1.9 NM from DER, 94' left of centerline, up to 858' MSL.  
 Trees beginning 1.9 NM from DER, 33' left of centerline, up to 890' MSL.  
 Building 2.1 NM from DER, 1474' right of centerline, 952' MSL.  
 Tower, trees, beginning 2.1 NM from DER, 508' right of centerline, up to 106' AGL/956' MSL.  
 Spires, building, tree beginning 2.2 NM from DER, 29' left of centerline, up to 78' AGL/891' MSL.  
 Antenna 2.2 NM from DER, 1215' right of centerline, 966' MSL.  
 Tower, trees, antenna beginning 2.2 NM from DER, 451' right of centerline, up to 125' AGL/969' MSL.  
 Tower 2.3 NM from DER, 535' left of centerline, 156' AGL/971' MSL.  
 Antenna, trees beginning 2.3 NM from DER, 118' left of centerline, up to 160' AGL/978' MSL.  
 Tree 2.5 NM from DER, 1167' right of centerline, 879' MSL.  
**Rwy 25**, terrain 2' from DER, 417' left of centerline, 483' MSL.  
 Fence 79' from DER, 460' right of centerline, 487' MSL.  
 Buildings, fence beginning 177' from DER, 47' left of centerline, up to 35' AGL/518' MSL.  
 Pole 182' from DER, 310' right of centerline, 511' MSL.  
 Trees, vehicle on road, transmission line, poles, terrain, buildings beginning 195' from DER, on centerline, up to 51' MSL.  
 Tree, buildings, poles beginning 513' from DER, on and left of centerline, up to 549' MSL.  
 Trees, terrain beginning 597' from DER, 50' left of centerline, up to 552' MSL.  
 Trees, transmission line, signs beginning 1176' from DER, 34' left of centerline, up to 553' MSL.  
 Trees beginning 1628' from DER, 95' right of centerline, up to 570' MSL.  
 Tree 3484' from DER, 393' right of centerline, 103' AGL/577' MSL.  
 Trees beginning 3531' from DER, 256' right of centerline, up to 589' MSL.  
 Trees, transmission line beginning 3650' from DER, 152' right of centerline, up to 604' MSL.  
 Tree 3733' from DER, 361' left of centerline, 101' AGL/578' MSL.  
 Trees beginning 3752' from DER, 119' left of centerline, up to 81' AGL/584' MSL.  
 Trees beginning 3753' from DER, 17' right of centerline, up to 605' MSL.  
 Trees beginning 3800' from DER, 288' right of centerline, up to 640' MSL.  
 Trees beginning 3830' from DER, 708' right of centerline, up to 660' MSL.  
 Trees beginning 3857' from DER, 45' left of centerline, up to 76' AGL/590' MSL.

CON'T

# TAKEOFF MINIMUMS, (OBSTACLE) DEPARTURE PROCEDURES, AND DIVERSE VECTOR AREA (RADAR VECTORS)

24025

# TAKEOFF MINIMUMS, (OBSTACLE) DEPARTURE PROCEDURES, AND DIVERSE VECTOR AREA (RADAR VECTORS)

24025

## CINCINNATI, OH (CON'T)

### CINCINNATI MUNI/LUNKEN FLD (LUK) (CON'T)

**Rwy 25 (CON'T)**, trees, transmission line beginning 3872' from DER, 175' right of centerline, up to 672' MSL.

Trees beginning 3896' from DER, 286' right of centerline, up to 708' MSL.

Trees beginning 3975' from DER, 159' right of centerline, up to 715' MSL.

Tree 4033' from DER, 1524' right of centerline, 721' MSL.

Trees beginning 4037' from DER, 167' left of centerline, up to 45' AGL/594' MSL.

Trees beginning 4049' from DER, 273' right of centerline, up to 740' MSL.

Trees, terrain beginning 4073' from DER, 495' right of centerline, up to 761' MSL.

Trees, terrain beginning 4096' from DER, 19' right of centerline, up to 779' MSL.

Tree 4104' from DER, 56' left of centerline, 87' AGL/600' MSL.

Trees beginning 4115' from DER, 554' left of centerline, up to 645' MSL.

Trees beginning 4139' from DER, 145' left of centerline, up to 106' AGL/651' MSL.

Trees beginning 4166' from DER, 270' left of centerline, up to 91' AGL/689' MSL.

Trees beginning 4184' from DER, 79' left of centerline, up to 77' AGL/704' MSL.

Trees beginning 4236' from DER, 172' left of centerline, up to 707' MSL.

Trees, terrain beginning 4284' from DER, 28' right of centerline, up to 800' MSL.

Trees beginning 4322' from DER, 30' left of centerline, up to 74' AGL/733' MSL.

Tree 4360' from DER, 520' left of centerline, 769' MSL.

Trees beginning 4374' from DER, 111' left of centerline, up to 780' MSL.

Trees beginning 4504' from DER, 482' left of centerline, up to 788' MSL.

Tree, terrain beginning 4512' from DER, 66' left of centerline, up to 797' MSL.

Trees, terrain, building beginning 4523' from DER, 39' right of centerline, up to 807' MSL.

Trees, buildings, terrain beginning 4690' from DER, 21' left of centerline, up to 814' MSL.

Tree, building, terrain beginning 4706' from DER, 81' right of centerline, up to 817' MSL.

Tree, terrain beginning 4830' from DER, 256' right of centerline, up to 825' MSL.

Trees, building, terrain beginning 4879' from DER, 137' right of centerline, up to 831' MSL.

Trees, terrain beginning 4939' from DER, 44' right of centerline, up to 843' MSL.

Tree 4974' from DER, 1637' left of centerline, 835' MSL.

Trees, terrain, buildings beginning 4980' from DER, 37' left of centerline, up to 862' MSL.

Trees beginning 5078' from DER, 340' right of centerline, up to 862' MSL.

Trees beginning 5134' from DER, 39' right of centerline, up to 864' MSL.

Trees, pole beginning 5206' from DER, 47' left of centerline, up to 869' MSL.

Trees beginning 5255' from DER, 292' right of centerline, up to 869' MSL.

Trees, transmission line beginning 5301' from DER, 136' right of centerline, up to 870' MSL.

Trees, transmission line beginning 5319' from DER, 36' right of centerline, up to 877' MSL.

Trees, terrain, buildings beginning 5394' from DER, 43' right of centerline, up to 903' MSL.

Trees, building beginning 5507' from DER, 44' left of centerline, up to 894' MSL.

Trees, building, terrain, transmission line beginning 5706' from DER, 22' right of centerline, up to 914' MSL.

Trees, building beginning 5741' from DER, 30' left of centerline, up to 903' MSL.

Trees, buildings, terrain, transmission line beginning 5849' from DER, 38' right of centerline, up to 919' MSL.

Trees beginning 1 NM from DER, 1108' right of centerline, up to 925' MSL.

Trees beginning 1 NM from DER, 34' right of centerline, up to 928' MSL.

Tree, building, transmission line, terrain beginning 1 NM from DER, 22' right of centerline, up to 932' MSL.

Trees, terrain, buildings, transmission line, tower, antenna beginning 1 NM from DER, 16' left of centerline, up to 917' MSL.

Trees, building, terrain, transmission line beginning 1.1 NM from DER, 3' right of centerline, up to 943' MSL.

Tank, trees beginning 1.4 NM from DER, 1580' right of centerline, up to 200' AGL/1024' MSL.

Tank, trees, terrain, buildings, transmission line beginning 1.4 NM from DER, 16' right of centerline, up to 1045' MSL.

Trees, transmission line, terrain, building beginning 1.4 NM from DER, 1' left of centerline, up to 919' MSL.

Trees, terrain, buildings, pole, beginning 1.5 NM from DER, 10' left of centerline, up to 926' MSL.

Tower 2.5 NM from DER, 2048' left of centerline, 158' AGL/885' MSL.

## CIRCLEVILLE, OH

### PICKAWAY COUNTY MEML (CYO)

#### TAKEOFF MINIMUMS AND (OBSTACLE) DEPARTURE PROCEDURES

ORIG 13NOV14 (21224) (FAA)

#### DEPARTURE PROCEDURE:

**Rwy 1**, climb heading 008° to 1300 before turning left.

#### TAKEOFF MINIMUMS:

**Rwy 1**, vehicle on road beginning 7' from DER, 447' right of centerline, up to 15' AGL/697' MSL.

Runway end identifier light with electrical system 41' from DER, 79' right of centerline, 5' AGL/687' MSL.

Runway end identifier light with electrical system 42' from DER, 82' left of centerline, 3' AGL/687' MSL.

Fence beginning 177' from DER, 250' left of centerline, up to 12' AGL/694' MSL.

Poles beginning 345' from DER, 518' right of centerline, up to 42' AGL/721' MSL.

Vehicle on road beginning 649' from DER, 16' left of centerline, up to 15' AGL/703' MSL.

Pole 667' from DER, 521' left of centerline, 29' AGL/711' MSL.

Tree 1887' from DER, 184' right of centerline, 54' AGL/740' MSL.

Tree 2251' from DER, 189' left of centerline, 59' AGL/745' MSL.

**Rwy 19**, terrain beginning 108' from DER, 267' right of centerline, up to 669' MSL.

Trees beginning 261' from DER, 64' left of centerline, up to 100' AGL/755' MSL.

Trees beginning 765' from DER, 99' right of centerline, up to 100' AGL/737' MSL.

# TAKEOFF MINIMUMS, (OBSTACLE) DEPARTURE PROCEDURES, AND DIVERSE VECTOR AREA (RADAR VECTORS)

24025

EC-2



# TAKEOFF MINIMUMS, (OBSTACLE) DEPARTURE PROCEDURES, AND DIVERSE VECTOR AREA (RADAR VECTORS)

24025

## CLEVELAND, OH

### BURKE LAKEFRONT (BKL)

#### TAKEOFF MINIMUMS AND (OBSTACLE) DEPARTURE PROCEDURES

AMDT 7A 07SEP23 (23250) (FAA)

#### TAKEOFF MINIMUMS:

**Rwy 6L**, 300-1¼ or std w/min climb of 220°/NM to 900.

**Rwy 6R**, 300-1½ or std w/min climb of 290°/NM to 1000. NA when tower is closed.

**Rwy 24L**, 400-1¾ or std w/min climb of 757°/NM to 1000. NA when tower is closed.

**Rwy 24R**, 300-1 or std w/min climb of 490°/NM to 900.

#### DEPARTURE PROCEDURE:

**Rwys 6L/R**, climbing left turn to 2000 on heading 350° to intercept CXR VOR/DME R-286 to CRIBS INT before proceeding on course.

**Rwys 24L/R**, climbing right turn to 2000 on heading 350° to intercept CXR VOR/DME R-286 to CRIBS INT before proceeding on course.

#### TAKEOFF OBSTACLE NOTES:

**Rwy 6L**, light pole 9' from DER, 54' left of centerline, 2' AGL/584' MSL.

Light pole, sign beginning 9' from DER, 55' right of centerline, up to 2' AGL/584' MSL.

Tree 842' from DER, 720' right of centerline, 622' MSL.

Pole 964' from DER, 235' left of centerline, 24' AGL/618' MSL.

Crane 969' from DER, 589' right of centerline, 73' AGL/641' MSL.

Tree 2294' from DER, 265' right of centerline, 650' MSL.

Transmission lines, poles, trees beginning 2297' from DER, 166' right of centerline, up to 91' AGL/675' MSL.

Buildings, bridge beginning 2682' from DER, 597' right of centerline, up to 124' AGL/704' MSL.

Tower 1 NM from DER, 1347' right of centerline, 150' AGL/758' MSL.

**Rwy 6R**, sign, light pole beginning 27' from DER, 89' left of centerline, up to 4' AGL/585' MSL.

Light pole 41' from DER, 89' right of centerline, 3' AGL/585' MSL.

Wind indicator 175' from DER, 242' left of centerline, 11' AGL/590' MSL.

Pole 177' from DER, 241' left of centerline, 14' AGL/594' MSL.

Pole 471' from DER, 612' right of centerline, 37' AGL/617' MSL.

Poles, sign beginning 626' from DER, 595' right of centerline, up to 37' AGL/618' MSL.

Poles beginning 1009' from DER, 569' right of centerline, up to 56' AGL/637' MSL.

Pole, dome beginning 1874' from DER, 568' right of centerline, up to 70' AGL/651' MSL.

Pole 3098' from DER, 1282' right of centerline, 49' AGL/661' MSL.

Pole 3372' from DER, 1289' right of centerline, 88' AGL/708' MSL.

Transmission lines, pole, building beginning 3720' from DER, 96' right of centerline, up to 93' AGL/714' MSL.

Tower, poles, building beginning 4310' from DER, 170' right of centerline, up to 106' AGL/737' MSL.

Antenna, towers beginning 1.2 NM from DER, 1827' right of centerline, up to 227' AGL/849' MSL.

**Rwy 24L**, light pole beginning 10' from DER, 29' left of centerline, up to 2' AGL/582' MSL.

Light pole 10' from DER, 29' right of centerline, 2' AGL/582' MSL.

Fence 184' from DER, 451' left of centerline, 9' AGL/590' MSL.

Building 197' from DER, 502' left of centerline, 27' AGL/610' MSL.

Building, tank beginning 213' from DER, 411' left of centerline, up to 30' AGL/613' MSL.

Pole 900' from DER, 621' left of centerline, 60' AGL/628' MSL.

Crane, poles, traverse way, building beginning 1038' from DER, 38' left of centerline, up to 85' AGL/653' MSL.

Pole 1319' from DER, 161' right of centerline, 64' AGL/632' MSL.

Building 1685' from DER, 684' left of centerline, 166' AGL/740' MSL.

Building 1727' from DER, 643' left of centerline, 169' AGL/741' MSL.

Buildings, bridges, dome, pole, traverse way beginning 1748' from DER, 196' left of centerline, up to 167' AGL/745' MSL.

Traverse way 2146' from DER, 90' right of centerline, 65' AGL/637' MSL.

Windmills beginning 2340' from DER, 1119' left of centerline, up to 152' AGL/750' MSL.

Stadiums, cranes beginning 2821' from DER, 317' left of centerline, up to 176' AGL/763' MSL.

Building, traverse ways, crane, elevator, bridge beginning 5056' from DER, 207' left of centerline, up to 275' AGL/896' MSL.

**Rwy 24R**, light pole 10' from DER, 55' right of centerline, 2' AGL/582' MSL.

Light pole, sign beginning 10' from DER, 55' left of centerline, up to 2' AGL/582' MSL.

Poles, traverse way beginning 1514' from DER, 338' left of centerline, up to 64' AGL/632' MSL.

Bridges beginning 2106' from DER, 695' left of centerline, up to 70' AGL/648' MSL.

Pole, traverse way beginning 2324' from DER, 866' left of centerline, up to 86' AGL/654' MSL.

Stadiums, cranes beginning 3015' from DER, 816' left of centerline, up to 176' AGL/763' MSL.

Crane 5727' from DER, 1699' right of centerline, 152' AGL/731' MSL.

#### DIVERSE VECTOR AREA (RADAR VECTORS)

ORIG 01FEB18 (18032) (FAA)

**Rwy 6L**, heading as assigned by ATC; requires min. climb of 220° per NM to 900.

**Rwy 6R**, heading as assigned by ATC; requires min. climb of 290° per NM to 1000.

**Rwy 24R**, heading as assigned by ATC; requires min. climb of 490° per NM to 900.

# TAKEOFF MINIMUMS, (OBSTACLE) DEPARTURE PROCEDURES, AND DIVERSE VECTOR AREA (RADAR VECTORS)

24025

# TAKEOFF MINIMUMS, (OBSTACLE) DEPARTURE PROCEDURES, AND DIVERSE VECTOR AREA (RADAR VECTORS)

24025

## CLEVELAND, OH (CON'T)

### CLEVELAND-HOPKINS INTL (CLE)

#### TAKEOFF MINIMUMS AND (OBSTACLE) DEPARTURE PROCEDURES

AMDT 16A 24MAY18 (18144) (FAA)

#### DEPARTURE PROCEDURE:

**Rwys 6R, 6L, 10**, climbing left turn to intercept DJB VOR/DME R-082 inbound to 2600 before proceeding on course.

#### TAKEOFF OBSTACLE NOTES:

**Rwy 10**, tree 828' from DER, 656' right of centerline, 821' MSL.

Tree 880' from DER, 662' right of centerline, 830' MSL.

Sign 906' from DER, 717' left of centerline, 28' AGL/830' MSL.

Pole 1415' from DER, 785' right of centerline, 48' AGL/842' MSL.

Sign 2149' from DER, 955' left of centerline, 59' AGL/857' MSL.

Tower 3826' from DER, 1455' right of centerline, 137' AGL/922' MSL.

**Rwy 24L**, tree 1903' from DER, 492' left of centerline, 69' AGL/839' MSL.

Trees beginning 1959' from DER, 19' left of centerline, up to 78' AGL/848' MSL.

Pole, tree beginning 2273' from DER, 4' left of centerline, up to 79' AGL/849' MSL.

**Rwy 24R**, tower 2565' from DER, 1028' right of centerline, 191' AGL/870' MSL.

Tree 3653' from DER, 1047' left of centerline, 103' AGL/863' MSL.

Tree 3754' from DER, 861' left of centerline, 98' AGL/868' MSL.

**Rwy 28**, tree, building beginning 80' from DER, 424' right of centerline, up to 788' MSL.

Trees beginning 890' from DER, 212' right of centerline, up to 803' MSL.

Trees beginning 1042' from DER, 26' right of centerline, up to 811' MSL.

Tree 1250' from DER, 107' left of centerline, 813' MSL.

Building, trees beginning 1267' from DER, 66' left of centerline, up to 92' AGL/851' MSL.

Pole 2970' from DER, 947' right of centerline, 82' AGL/842' MSL.

## CUYAHOGA COUNTY (CGF)

### TAKEOFF MINIMUMS AND (OBSTACLE) DEPARTURE PROCEDURES

AMDT 2 08NOV18 (18312) (FAA)

#### TAKEOFF OBSTACLE NOTES:

**Rwy 6**, terrain 86' from DER, 56' right of centerline, 878' MSL.

Terrain beginning 105' from DER, 26' left of centerline, up to 878' MSL.

Terrain 141' from DER, 37' right of centerline, 879' MSL.

Tree 1757' from DER, 929' left of centerline, 938' MSL.

Trees beginning 2163' from DER, 1008' right of centerline, up to 975' MSL.

Tree 2300' from DER, 1104' left of centerline, 961' MSL.

Trees beginning 2917' from DER, 105' right of centerline, up to 980' MSL.

Trees beginning 3607' from DER, 59' right of centerline, up to 982' MSL.

**Rwy 24**, pole 423' from DER, 423' right of centerline, 38' AGL/895' MSL.

NAVAID 530' from DER, 195' left of centerline, 19' AGL/894' MSL.

Tree, building beginning 617' from DER, 603' left of centerline, up to 940' MSL.

Tree 1141' from DER, 716' left of centerline, 945' MSL.

Trees beginning 1289' from DER, 555' left of centerline, up to 956' MSL.

Trees beginning 1366' from DER, 438' left of centerline, up to 970' MSL.

Trees beginning 1896' from DER, 95' left of centerline, up to 974' MSL.

Tree 1992' from DER, 76' right of centerline, 944' MSL.

Tree 2149' from DER, 8' right of centerline, 945' MSL.

Tree 3504' from DER, 31' right of centerline, 975' MSL.

Trees beginning 3616' from DER, 164' right of centerline, up to 979' MSL.

Tree 3714' from DER, 409' left of centerline, 975' MSL.

Tree 4153' from DER, 4' left of centerline, 980' MSL.

## COLUMBUS, IN

### COLUMBUS MUNI (BAK)

#### TAKEOFF MINIMUMS AND (OBSTACLE) DEPARTURE PROCEDURES

ORIG 25SEP08 (08269) (FAA)

#### TAKEOFF OBSTACLE NOTES:

**Rwy 14**, tree 1589' from DER, 306' right of centerline, 40' AGL/696' MSL.

# TAKEOFF MINIMUMS, (OBSTACLE) DEPARTURE PROCEDURES, AND DIVERSE VECTOR AREA (RADAR VECTORS)

24025

# TAKEOFF MINIMUMS, (OBSTACLE) DEPARTURE PROCEDURES, AND DIVERSE VECTOR AREA (RADAR VECTORS)

24025

## COLUMBUS, OH

### BOLTON FLD (TZR)

#### TAKEOFF MINIMUMS AND (OBSTACLE) DEPARTURE PROCEDURES

ORIG 15JAN09 (21112) (FAA)

DEPARTURE PROCEDURE:

**Rwy 4**, climb heading 037° to 1800 before turning east.

TAKEOFF OBSTACLE NOTES:

**Rwy 4**, tree 1091' from DER, 770' left of centerline, 53' AGL/959' MSL.

Tree 487' from DER, 356' right of centerline, 23' AGL/929' MSL.

Tree 1317' from DER, 452' right of centerline, 42' AGL/948' MSL.

Tree 1307' from DER, 50' left of centerline, 36' AGL/942' MSL.

Tree 1927' from DER, 135' right of centerline, 49' AGL/955' MSL.

**Rwy 22**, tree 1273' from DER, 720' right of centerline, 40' AGL/945' MSL.

Tree 712' from DER, 662' right of centerline, 25' AGL/927' MSL.

Tree 1411' from DER, 658' right of centerline 33' AGL/939' MSL.

## JOHN GLENN COLUMBUS INTL (CMH)

#### TAKEOFF MINIMUMS AND (OBSTACLE) DEPARTURE PROCEDURES

AMDT 7A 17AUG17 (17229) (FAA)

DEPARTURE PROCEDURE:

**Rwy 28L**, climb heading 281° to 2100 before turning southbound.

**Rwy 28R**, climb heading 281° to 2000 before turning southbound.

TAKEOFF OBSTACLE NOTES:

**Rwy 10L**, sign 23' from DER, 348' right of centerline, 3' AGL/813' MSL.

Trees beginning 1308' from DER, 800' left of centerline, up to 79' AGL/869' MSL.

Trees beginning 1721' from DER, 764' right of centerline, up to 88' AGL/878' MSL.

**Rwy 10R**, aircraft on taxiway abeam DER, 290' right of centerline, up to 59' AGL/878' MSL.

Sign 42' from DER, 159' left of centerline, 6' AGL/817' MSL.

Poles and building beginning 934' from DER, 538' right of centerline, up to 42' AGL/852' MSL.

Trees beginning 1319' from DER, 225' right of centerline, up to 116' AGL/886' MSL.

**Rwy 28L**, building 42' from DER, 111' right of centerline, 6' AGL/810' MSL.

Trees beginning 1563' from DER, 870' left of centerline, up to 93' AGL/902' MSL.

**Rwy 28R**, tower 1260' from DER, 837' left of centerline, 75' AGL/875' MSL.

Trees and poles beginning 1228' from DER, 624' right of centerline, up to 72' AGL/882' MSL.

Light 5' from DER, 4' left of centerline, 1' AGL/815' MSL.

## OHIO STATE UNIVERSITY (OSU)

#### TAKEOFF MINIMUMS AND (OBSTACLE) DEPARTURE PROCEDURES

ORIG-A 14JUL22 (22195) (FAA)

TAKEOFF OBSTACLE NOTES:

**Rwy 5**, tree 675' from DER, 675' right of centerline, 22' AGL/910' MSL.

Buildings beginning 966' from DER, 528' left of centerline, up to 50' AGL/936' MSL.

Tree, building beginning 1122' from DER, 587' left of centerline, up to 937' MSL.

Tree 1303' from DER, 164' right of centerline, 52' AGL/929' MSL.

Trees beginning 1331' from DER, 43' left of centerline, up to 946' MSL.

Trees beginning 1374' from DER, 46' right of centerline, up to 52' AGL/931' MSL.

Trees beginning 1405' from DER, 98' right of centerline, up to 57' AGL/973' MSL.

Trees beginning 1408' from DER, 2' right of centerline, up to 61' AGL/941' MSL.

Trees beginning 1421' from DER, 46' right of centerline, up to 958' MSL.

Trees beginning 1474' from DER, 4' left of centerline, up to 73' AGL/954' MSL.

Trees beginning 1505' from DER, 40' left of centerline, up to 84' AGL/964' MSL.

Trees beginning 1532' from DER, 51' left of centerline, up to 967' MSL.

Trees beginning 1548' from DER, 25' left of centerline, up to 973' MSL.

Trees beginning 1633' from DER, 9' right of centerline, up to 962' MSL.

Trees beginning 1637' from DER, 20' left of centerline, up to 98' AGL/975' MSL.

Trees beginning 1685' from DER, 31' right of centerline, up to 966' MSL.

Trees beginning 1781' from DER, 69' right of centerline, up to 96' AGL/969' MSL.

Trees beginning 1859' from DER, 169' right of centerline, up to 107' AGL/973' MSL.

Trees beginning 1886' from DER, 156' right of centerline, up to 101' AGL/974' MSL.

Trees beginning 1891' from DER, 4' right of centerline, up to 101' AGL/976' MSL.

Trees beginning 1920' from DER, 7' right of centerline, up to 103' AGL/979' MSL.

**Rwy 9L**, sign 68' from DER, 225' left of centerline, 4' AGL/894' MSL.

Tree 909' from DER, 634' left of centerline, 44' AGL/923' MSL.

Trees beginning 914' from DER, 547' left of centerline, up to 50' AGL/930' MSL.

Trees beginning 949' from DER, 548' left of centerline, up to 52' AGL/931' MSL.

Tree 953' from DER, 686' left of centerline, 61' AGL/941' MSL.

Trees beginning 958' from DER, 515' left of centerline, up to 68' AGL/948' MSL.

Trees beginning 1016' from DER, 531' left of centerline, up to 958' MSL.

Trees beginning 1301' from DER, 702' left of centerline, up to 90' AGL/965' MSL.

Trees beginning 1328' from DER, 575' left of centerline, up to 966' MSL.

Trees beginning 1393' from DER, 340' left of centerline, up to 98' AGL/969' MSL.

Trees beginning 1477' from DER, 7' left of centerline, up to 107' AGL/973' MSL.

Trees beginning 1590' from DER, 230' right of centerline, up to 72' AGL/942' MSL.

Trees beginning 2000' from DER, 7' right of centerline, up to 960' MSL.

CONT

# TAKEOFF MINIMUMS, (OBSTACLE) DEPARTURE PROCEDURES, AND DIVERSE VECTOR AREA (RADAR VECTORS)

24025

EC-2

# TAKEOFF MINIMUMS, (OBSTACLE) DEPARTURE PROCEDURES, AND DIVERSE VECTOR AREA (RADAR VECTORS)

24025

## COLUMBUS, OH (CON'T)

### OHIO STATE UNIVERSITY (OSU) (CON'T)

**Rwy 9R**, tree 64' from DER, 302' left of centerline, 15' AGL/894' MSL.  
Trees beginning 201' from DER, 252' left of centerline, up to 918' MSL.  
Tree 377' from DER, 511' right of centerline, 907' MSL.  
Trees beginning 882' from DER, 378' right of centerline, up to 937' MSL.  
Trees beginning 993' from DER, 265' left of centerline, up to 56' AGL/924' MSL.  
Trees beginning 1033' from DER, 367' right of centerline, up to 940' MSL.  
Trees beginning 1084' from DER, 270' left of centerline, up to 63' AGL/932' MSL.  
Trees beginning 1299' from DER, 337' right of centerline, up to 943' MSL.  
Trees beginning 1308' from DER, 531' left of centerline, up to 940' MSL.  
Tree 1341' from DER, 515' right of centerline, 945' MSL.  
Trees beginning 1400' from DER, 460' right of centerline, up to 955' MSL.  
Trees beginning 1813' from DER, 556' right of centerline, up to 965' MSL.  
Tree 2413' from DER, 961' left of centerline, 96' AGL/953' MSL.  
**Rwy 23**, building 494' from DER, 468' left of centerline, 930' MSL.  
Tree, building beginning 544' from DER, 396' left of centerline, up to 944' MSL.  
Tree 658' from DER, 624' left of centerline, 945' MSL.  
Stack, tank, trees beginning 673' from DER, 261' left of centerline, up to 60' AGL/963' MSL.  
Tree 1197' from DER, 208' right of centerline, 45' AGL/942' MSL.  
Tree 1919' from DER, 213' right of centerline, 58' AGL/957' MSL.  
Tree 1995' from DER, 257' right of centerline, 64' AGL/965' MSL.  
Trees beginning 2000' from DER, 167' right of centerline, up to 78' AGL/978' MSL.  
Tree 2081' from DER, 312' right of centerline, 989' MSL.  
Trees beginning 2257' from DER, 351' right of centerline, up to 97' AGL/999' MSL.  
**Rwy 27L**, lighting 4' from DER, 4' left of centerline, 2' AGL/903' MSL.  
Tree 291' from DER, 575' left of centerline, 910' MSL.  
**Rwy 27R**, sign 15' from DER, 247' left of centerline, 3' AGL/906' MSL.  
Tree 2330' from DER, 861' right of centerline, 964' MSL.  
Tree 2479' from DER, 789' right of centerline, 974' MSL.

## CONNERSVILLE, IN

### METTEL FLD (CEV)

#### TAKEOFF MINIMUMS AND (OBSTACLE) DEPARTURE PROCEDURES

AMDT 2 28SEP06 (21224) (FAA)

##### TAKEOFF MINIMUMS:

**Rwys 4, 22**, NA-VFR use only.

##### DEPARTURE PROCEDURE:

**Rwy 18**, climb via heading 185° to 1500 before proceeding on course.

##### TAKEOFF OBSTACLE NOTES:

**Rwy 18**, railroad 311' from DER, 580' left of centerline, 23' AGL/882' MSL.  
Multiple trees beginning 2280' from DER, 100' left of centerline, up to 113' AGL/974' MSL.  
**Rwy 36**, road 120' from DER, 301' right of centerline, 15' AGL/884' MSL.  
Railroad 649' from DER, 578' right of centerline, 23' AGL/892' MSL.  
Multiple trees beginning 3400' from DER, on centerline, up to 92' AGL/959' MSL.

## COSHOCTON, OH

### RICHARD DOWNING (140)

#### TAKEOFF MINIMUMS AND (OBSTACLE) DEPARTURE PROCEDURES

AMDT 1A 15SEP16 (16259) (FAA)

##### TAKEOFF MINIMUMS:

**Rwys 4, 22**, 300-1.

##### TAKEOFF OBSTACLE NOTES:

**Rwy 4**, tree 87' from DER, 402' left of centerline, 981' MSL.  
Trees beginning 88' from DER, 460' left of centerline, up to 84' AGL/1040' MSL.  
Tree 90' from DER, 226' right of centerline, 983' MSL.  
Tree 628' from DER, 509' right of centerline, 1006' MSL.  
**Rwy 22**, trees beginning 2' from DER, 290' left of centerline, up to 988' MSL.  
Pole, wsk beginning 11' from DER, 57' right of centerline, up to 7' AGL/979' MSL.  
Trees beginning 179' from DER, 275' left of centerline, up to 84' AGL/999' MSL.  
Trees beginning 1033' from DER, 595' left of centerline, up to 1042' MSL.  
Tree 2420' from DER, 123' right of centerline, 96' AGL/1035' MSL.  
Tree 2442' from DER, 52' right of centerline, 104' AGL/1043' MSL.  
Trees beginning 2443' from DER, 21' right of centerline, up to 106' AGL/1050' MSL.  
Trees beginning 2496' from DER, 3' left of centerline, up to 103' AGL/1045' MSL.  
Trees beginning 2503' from DER, on centerline, up to 103' AGL/1054' MSL.  
Trees beginning 2550' from DER, 43' right of centerline, up to 105' AGL/1061' MSL.

22 FEB 2024 to 21 MAR 2024

22 FEB 2024 to 21 MAR 2024

# TAKEOFF MINIMUMS, (OBSTACLE) DEPARTURE PROCEDURES, AND DIVERSE VECTOR AREA (RADAR VECTORS)

24025

EC-2

# TAKEOFF MINIMUMS, (OBSTACLE) DEPARTURE PROCEDURES, AND DIVERSE VECTOR AREA (RADAR VECTORS)

24025

## CRAWFORDSVILLE, IN

CRAWFORDSVILLE RGNL (CFJ)

TAKEOFF MINIMUMS AND (OBSTACLE) DEPARTURE PROCEDURES

AMDT 1A 08NOV18 (18312) (FAA)

TAKEOFF OBSTACLE NOTES:

**Rwy 4**, poles beginning 805' from DER, 224' right of centerline, up to 27' AGL/829' MSL.

Tree 2838' from DER, 256' right of centerline, 873' MSL.

Poles, terrain, vehicle on road, tree beginning 41' from DER, 54' left of centerline, up to 30' AGL/834' MSL.

Tree 822' from DER, 95' left of centerline, 841' MSL.

Trees beginning 856' from DER, 123' left of centerline, up to 843' MSL.

Trees beginning 957' from DER, 213' left of centerline, up to 849' MSL.

Tree 1055' from DER, 283' left of centerline, 850' MSL.

Tree 1229' from DER, 418' left of centerline, 853' MSL.

Tree 1312' from DER, 168' left of centerline, 873' MSL.

Trees beginning 1324' from DER, 268' left of centerline, up to 875' MSL.

Trees beginning 1559' from DER, 283' left of centerline, up to 876' MSL.

Trees beginning 1862' from DER, 219' left of centerline, up to 881' MSL.

**Rwy 22**, tree 653' from DER, 618' right of centerline, 846' MSL.

Trees beginning 789' from DER, 205' right of centerline, up to 852' MSL.

Trees beginning 1059' from DER, 191' right of centerline, up to 857' MSL.

Trees beginning 2797' from DER, 386' right of centerline, up to 879' MSL.

Tree 328' from DER, 508' left of centerline, 815' MSL.

Trees beginning 559' from DER, 176' left of centerline, up to 867' MSL.

## DAYTON, OH

DAYTON/PHILLIPSBURG (3I7)

TAKEOFF MINIMUMS AND (OBSTACLE) DEPARTURE PROCEDURES

AMDT 1A 16AUG18 (22251) (FAA)

TAKEOFF MINIMUMS:

**Rwy 21**, 300-1.

## DAYTON/WRIGHT BROTHERS (MGY)

TAKEOFF MINIMUMS AND (OBSTACLE) DEPARTURE PROCEDURES

AMDT 3A 21JUL16 (22307) (FAA)

TAKEOFF OBSTACLE NOTES:

**Rwy 2**, multiple trees and road beginning 440' from DER, 257' left of centerline, up to 100' AGL/1053' MSL.

Multiple trees beginning 672' from DER, 17' right of centerline, up to 100' AGL/1017' MSL.

**Rwy 20**, multiple trees beginning 189' from DER, 494' left of centerline, up to 100' AGL/1009' MSL.

Multiple poles and trees beginning 323' from DER, 364' right of centerline, up to 100' AGL/1026' MSL.

Building 1195' from DER, 512' right of centerline, 50' AGL/972' MSL.

## GREENE COUNTY/LEWIS A JACKSON RGNL (GDK)

TAKEOFF MINIMUMS AND (OBSTACLE) DEPARTURE PROCEDURES

AMDT 3 30NOV23 (23334) (FAA)

DEPARTURE PROCEDURE:

**Rwy 25**, climb on heading 233° to 1700 before turning right.

TAKEOFF OBSTACLE NOTES:

**Rwy 7**, trees, wind indicator beginning 20' from DER, 133' right of centerline, up to 59' AGL/999' MSL.

Tree 73' from DER, 264' left of centerline, 983' MSL.

Trees beginning 111' from DER, 165' left of centerline, up to 986' MSL.

Trees beginning 642' from DER, 329' right of centerline, up to 1016' MSL.

Trees beginning 2361' from DER, 945' right of centerline, up to 1028' MSL.

**Rwy 25**, trees beginning 51' from DER, 491' left of centerline, up to 998' MSL.

Trees, transmission lines, poles beginning 176' from DER, 278' left of centerline, up to 998' MSL.

Trees beginning 266' from DER, 320' right of centerline, up to 954' MSL.

Transmission line, poles beginning 1122' from DER, 578' right of centerline, up to 81' AGL/972' MSL.

Pole 1409' from DER, 764' right of centerline, 992' MSL.

Transmission line 1410' from DER, 753' right of centerline, 137' AGL/1005' MSL.

Trees beginning 1834' from DER, 320' left of centerline, up to 1002' MSL.

Trees beginning 1983' from DER, 426' left of centerline, up to 127' AGL/1011' MSL.

22 FEB 2024 to 21 MAR 2024

22 FEB 2024 to 21 MAR 2024

# TAKEOFF MINIMUMS, (OBSTACLE) DEPARTURE PROCEDURES, AND DIVERSE VECTOR AREA (RADAR VECTORS)

24025

EC-2

# TAKEOFF MINIMUMS, (OBSTACLE) DEPARTURE PROCEDURES, AND DIVERSE VECTOR AREA (RADAR VECTORS)

24025

## DAYTON, OH (CON'T)

### JAMES M COX DAYTON INTL (DAY)

#### TAKEOFF MINIMUMS AND (OBSTACLE) DEPARTURE PROCEDURES

AMDT 4 27APR17 (17117) (FAA)

##### TAKEOFF MINIMUMS:

**Rwy 18**, 300-1 or std. w/min. climb of 305 per NM to 1300.

##### TAKEOFF OBSTACLE NOTES:

**Rwy 6R**, tower 3128' from DER, 1114' right of centerline, 140' AGL/1101' MSL.

**Rwy 18**, trees beginning 1033' from DER, 77' right of centerline, up to 1048' MSL.

Tree 1047' from DER, 38' left of centerline, 1039' MSL.

Tree 1049' from DER, 326' left of centerline, 1040' MSL.

Tree 1050' from DER, 437' left of centerline, 1041' MSL.

Trees beginning 1051' from DER, 192' left of centerline, up to 1047' MSL.

Wind indicator on building, steeple, pole, ant on building, tree beginning 1141' from DER, 195' left of centerline, up to 1049' MSL.

Trees beginning 1378' from DER, 325' left of centerline, up to 1056' MSL.

Trees beginning 1618' from DER, 244' left of centerline, up to 1060' MSL.

Tree 1631' from DER, 558' right of centerline, 1054' MSL.

Tree 1711' from DER, 185' left of centerline, 1066' MSL.

Trees beginning 1785' from DER, 311' left of centerline, up to 1072' MSL.

Trees beginning 1825' from DER, 210' left of centerline, up to 74' AGL/1079' MSL.

Tree 1832' from DER, 563' right of centerline, 1060' MSL.

Trees beginning 2013' from DER, 139' right of centerline, up to 1072' MSL.

Trees beginning 2322' from DER, 958' right of centerline, up to 1073' MSL.

Tree 2378' from DER, 916' left of centerline, 1089' MSL.

Trees beginning 2379' from DER, 141' left of centerline, up to 96' AGL/1095' MSL.

Tree 2574' from DER, 1075' right of centerline, 1094' MSL.

Tree 2578' from DER, 1098' right of centerline, 89' AGL/1096' MSL.

Trees beginning 2923' from DER, 412' left of centerline, up to 1098' MSL.

Tank 4227' from DER, 1469' left of centerline, 184' AGL/1168' MSL.

**Rwy 24L**, vehicles on road 200' from DER, crossing runway centerline, up to 15' AGL/1021' MSL.

Tree 992' from DER, 522' left of centerline, 1049' MSL.

Tree 1139' from DER, 740' left of centerline, 1056' MSL.

Trees beginning 1722' from DER, 527' left of centerline, up to 1061' MSL.

**Rwy 36**, airfield light beginning 5' from DER, 4' right of centerline, up to 2' AGL/992' MSL.

Tree 1947' from DER, 939' left of centerline, 1040' MSL.

## MORAIN AIR PARK (I73)

#### TAKEOFF MINIMUMS AND (OBSTACLE) DEPARTURE PROCEDURES

ORIG 03NOV22 (22307) (FAA)

##### TAKEOFF MINIMUMS:

**Rwy 8**, std. w/min. climb of 272' per NM to 2400 or 1700-3 for VCOA.

**Rwy 26**, std. w/min. climb of 269' per NM to 2200 or 1700-3 for VCOA.

##### DEPARTURE PROCEDURE:

**Rwy 8**, climb on heading 084° to 1700 before proceeding on course.

**Rwy 26**, climb on heading 264° to 1900 before proceeding on course.

##### VCOA:

**Rwys 8, 26**, obtain ATC approval for VCOA when requesting IFR clearance. Climb in visual conditions to cross Moraine Air Park at or above 2300 before proceeding on course.

##### TAKEOFF OBSTACLE NOTES:

**Rwy 8**, airport equipment 172' from DER, 112' right of centerline, 10' AGL/730' MSL.

Airport equipment, bldg, catenary, sign, pole beginning 363' from DER, 54' left of centerline, up to 50' AGL/770' MSL.

Bldgs beginning 532' from DER, 417' right of centerline, up to 30' AGL/750' MSL.

Pole 892' from DER, 344' right of centerline, 37' AGL/757' MSL.

Pole 895' from DER, 347' right of centerline, 37' AGL/772' MSL.

Poles, catenary beginning 962' from DER, 19' right of centerline, up to 37' AGL/775' MSL.

Poles beginning 1422' from DER, 102' left of centerline, up to 37' AGL/772' MSL.

**Rwy 26**, catenaries beginning 1351' from DER, 5' left of centerline, up to 50' AGL/770' MSL.

Pole 1364' from DER, 172' right of centerline, 37' AGL/757' MSL.

Catenaries, pole, silo beginning 1400' from DER, 58' right of centerline, up to 50' AGL/770' MSL.

## DEFIANCE, OH

### DEFIANCE MEML (DFI)

#### TAKEOFF MINIMUMS AND (OBSTACLE) DEPARTURE PROCEDURES

ORIG 10MAR11 (21224) (FAA)

##### TAKEOFF OBSTACLE NOTES:

**Rwy 12**, trees beginning 398' from DER, 155' right of centerline, up to 50' AGL/749' MSL.

Terrain beginning 62' from DER, 1' right of centerline, up to 706' MSL.

Vehicle on road 833' from DER, 286' left of centerline, up to 15' AGL/724' MSL.

**Rwy 30**, trees and power lines beginning 527' from DER, beginning 248' left to right of centerline, up to 50' AGL/759' MSL.

Vehicle on road beginning 527' from DER, 246' left to right of centerline, up to 15' AGL/724' MSL.

Terrain beginning 36' from DER, 17' right of centerline, up to 712' MSL.

Terrain beginning 116' from DER, 353' left of centerline, up to 712' MSL.

# TAKEOFF MINIMUMS, (OBSTACLE) DEPARTURE PROCEDURES, AND DIVERSE VECTOR AREA (RADAR VECTORS)

24025

# TAKEOFF MINIMUMS, (OBSTACLE) DEPARTURE PROCEDURES, AND DIVERSE VECTOR AREA (RADAR VECTORS)

24025

## DELAWARE, OH

DELAWARE MUNI/JIM MOORE FLD (DLZ)

TAKEOFF MINIMUMS AND (OBSTACLE) DEPARTURE PROCEDURES

AMDT 1 05JAN17 (22027) (FAA)

TAKEOFF OBSTACLE NOTES:

- Rwy 10**, tree 884' from DER, 717' left of centerline, 1014' MSL.
- Transmission line/tower 1179' from DER, 289' right of centerline, 48' AGL/987' MSL.
- Tree 1808' from DER, 506' left of centerline, 996' MSL.
- Rwy 28**, windsock 7' from DER, 443' right of centerline, 9' AGL/950' MSL.
- Ground 35' from DER, 189' left of centerline, 950' MSL.
- Transmission line/tower 992' from DER, 699' left of centerline, 61' AGL/1005' MSL.
- Transmission line/tower 987' from DER, 599' left of centerline, 45' AGL/987' MSL.
- Transmission line/tower 1126' from DER, 695' right of centerline, 45' AGL/988' MSL.
- Tree 1233' from DER, 742' right of centerline, 990' MSL.

## DELPHI, IN

DELPHI MUNI (119)

TAKEOFF MINIMUMS AND (OBSTACLE) DEPARTURE PROCEDURES

ORIG 15JUN23 (23166) (FAA)

TAKEOFF OBSTACLE NOTES:

- Pole 18**, pole 926' from DER, 643' left of centerline, 26' AGL/702' MSL.
- Pole beginning 929' from DER, 283' right of centerline, up to 29' AGL/697' MSL.
- Rwy 36**, light poles 1' from DER, 104' right of centerline, 2' AGL/671' MSL.
- Building 63' from DER, 334' left of centerline, 21' AGL/693' MSL.
- Tree, building, traverse way, pole beginning 127' from DER, 8' left of centerline, up to 55' AGL/727' MSL.
- Traverse way beginning 315' from DER, 86' right of centerline, up to 685' MSL.
- Tree 1435' from DER, 614' right of centerline, 55' AGL/715' MSL.

## EAST LIVERPOOL, OH

COLUMBIANA COUNTY (02G)

TAKEOFF MINIMUMS AND (OBSTACLE) DEPARTURE PROCEDURES

AMDT 2A 17AUG17 (17229) (FAA)

TAKEOFF MINIMUMS:

- Rwy 25**, 600-1¼ or std. w/min. climb gradient of 445' per NM to 1700.

DEPARTURE PROCEDURE:

- Rwy 25**, climb heading of 249° to 1700 before turning right.

TAKEOFF OBSTACLE NOTES:

- Rwy 7**, trees beginning abeam DER, 392' left of centerline, up to 71' AGL/1224' MSL.
- Tree 156' from DER, 449' right of centerline, 1205' MSL.
- Trees beginning 164' from DER, 11' left of centerline, up to 101' AGL/1231' MSL.
- Trees beginning 182' from DER, 75' right of centerline, up to 1218' MSL.
- Trees beginning 1892' from DER, 635' right of centerline, up to 1219' MSL.
- Tree 2212' from DER, 850' right of centerline, 1221' MSL.
- Tree 2338' from DER, 840' right of centerline, 1224' MSL.
- Tree 2859' from DER, 506' left of centerline, 1236' MSL.
- Rwy 25**, ground 7' from DER, 401' right of centerline, 1152' MSL.
- Ground beginning 104' from DER, 297' right of centerline, up to 1159' MSL.
- Ground 118' from DER, 256' left of centerline, 1148' MSL.
- Trees beginning 141' from DER, 28' left of centerline, up to 82' AGL/1226' MSL.
- Trees beginning 899' from DER, 84' right of centerline, up to 1220' MSL.
- Tree 3443' from DER, 611' right of centerline, 1240' MSL.
- Tree 3499' from DER, 359' right of centerline, 1242' MSL.
- Tree 3531' from DER, 1397' right of centerline, 1247' MSL.
- Tree 3533' from DER, 935' right of centerline, 1276' MSL.
- Trees beginning 3535' from DER, 161' right of centerline, up to 1287' MSL.
- Trees beginning 3653' from DER, 391' right of centerline, up to 1288' MSL.
- Trees beginning 3701' from DER, 61' right of centerline, up to 1290' MSL.
- Trees beginning 3748' from DER, 231' right of centerline, up to 1315' MSL.
- Tree 3748' from DER, 891' right of centerline, 1298' MSL.
- Trees beginning 3801' from DER, 44' right of centerline, up to 1322' MSL.
- Trees beginning 3854' from DER, 358' right of centerline, up to 1332' MSL.
- Tree, ground beginning 3907' from DER, 282' right of centerline, up to 1350' MSL.
- Trees beginning 4863' from DER, 804' left of centerline, up to 1279' MSL.
- Trees beginning 5051' from DER, 651' left of centerline, up to 1292' MSL.
- Trees beginning 5174' from DER, 546' left of centerline, up to 1296' MSL.
- Trees beginning 5280' from DER, 328' left of centerline, up to 1311' MSL.
- Trees beginning 5491' from DER, 59' left of centerline, up to 1316' MSL.
- Trees beginning 5860' from DER, 639' right of centerline, up to 1353' MSL.
- Trees beginning 5860' from DER, 120' right of centerline, up to 1355' MSL.
- Trees beginning 5966' from DER, 1071' right of centerline, up to 1356' MSL.
- Trees beginning 6019' from DER, 795' right of centerline, up to 1357' MSL.
- Trees beginning 6072' from DER, 15' right of centerline, up to 1364' MSL.
- Trees beginning 6072' from DER, 203' right of centerline, up to 1365' MSL.

CONT'

# TAKEOFF MINIMUMS, (OBSTACLE) DEPARTURE PROCEDURES, AND DIVERSE VECTOR AREA (RADAR VECTORS)

24025

EC-2

# TAKEOFF MINIMUMS, (OBSTACLE) DEPARTURE PROCEDURES, AND DIVERSE VECTOR AREA (RADAR VECTORS)

24025

## EAST LIVERPOOL, OH (CON'T) COLUMBIANA COUNTY (02G) (CON'T)

**Rwy 25 (CON'T)**, trees beginning 1 NM from DER, 26' right of centerline, up to 1389' MSL.  
Trees beginning 1 NM from DER, 25' left of centerline, up to 1325' MSL.  
Trees beginning 1 NM from DER, 332' right of centerline, up to 1393' MSL.  
Trees beginning 1 NM from DER, 84' right of centerline, up to 1406' MSL.  
Tree, ground beginning 1 NM from DER, 430' right of centerline, up to 76' AGL/1418' MSL.  
Trees beginning 1 NM from DER, 943' right of centerline, up to 1416' MSL.  
Transmission tower, tree, ground beginning 1.1 NM from DER, 687' right of centerline, up to 122' AGL/1450' MSL.  
Tree 1.4 NM from DER, 2655' left of centerline, 1359' MSL.  
Tree 1.4 NM from DER, 2747' left of centerline, 1360' MSL.

## ELKHART, IN

### ELKHART MUNI (EKM) TAKEOFF MINIMUMS AND (OBSTACLE) DEPARTURE PROCEDURES ORIG 22SEP11 (11265) (FAA)

#### TAKEOFF OBSTACLE NOTES:

**Rwy 9**, trees beginning 2039' from DER, 768' right of centerline, up to 68' AGL/845' MSL.  
Trees beginning 2649' from DER, 774' left of centerline, up to 90' AGL/867' MSL.  
**Rwy 18**, trees and spire beginning 592' from DER, 63' right of centerline, up to 63' AGL/835' MSL.  
Trees beginning 508' from DER, 87' left of centerline, up to 71' AGL/843' MSL.  
**Rwy 27**, trees beginning 1195' from DER, 241' right of centerline, up to 90' AGL/861' MSL.  
Trees beginning 1714' from DER, 49' left of centerline, up to 89' AGL/860' MSL.  
**Rwy 36**, tree and building beginning 845' from DER, 212' right of centerline, up to 58' AGL/836' MSL.  
Trees beginning 1193' from DER, 240' left of centerline, up to 61' AGL/839' MSL.

## ELYRIA, OH

### ELYRIA (1G1) TAKEOFF MINIMUMS AND (OBSTACLE) DEPARTURE PROCEDURES AMDT 2 08JUN06 (22083) (FAA)

#### TAKEOFF OBSTACLE NOTES:

**Rwy 9**, road 1198' from DER, 275' left of centerline, 15' AGL/774' MSL.  
Tree 2077' from DER, 778' right of centerline, 100' AGL/859' MSL.  
**Rwy 27**, tree 68' from DER, 237' left of centerline, 100' AGL/859' MSL.  
Tree 527' from DER, 454' right of centerline, 100' AGL/854' MSL.

## EVANSVILLE, IN

### EVANSVILLE RGNL (EVV) TAKEOFF MINIMUMS AND (OBSTACLE) DEPARTURE PROCEDURES AMDT 9A 22APR21 (21112) (FAA)

#### TAKEOFF MINIMUMS:

**Rwy 9**, 300-1 or std. w/min. climb of 695' per NM to 700.  
**Rwy 27**, 300-1½ or std. w/min. climb of 402' per NM to 800.  
**Rwy 36**, 300-1½ or std. w/min. climb of 635' per NM to 700.

#### TAKEOFF OBSTACLE NOTES:

**Rwy 9**, fence 293' from DER, 294' right of centerline, 9' AGL/399' MSL.  
Buildings 1441' from DER, on centerline, 40' AGL/455' MSL.  
Tree 2070' from DER, 1008' right of centerline, 98' AGL/563' MSL.  
Tree 2270' from DER, 905' right of centerline, 84' AGL/564' MSL.  
Tree 2298' from DER, 1108' right of centerline, 84' AGL/576' MSL.  
Tree 2399' from DER, 1100' right of centerline, 92' AGL/583' MSL.  
Tree 2442' from DER, 1034' right of centerline, 92' AGL/576' MSL.  
Tree 3093' from DER, 1250' left of centerline, 91' AGL/511' MSL.  
Tree 3998' from DER, 386' left of centerline, 90' AGL/516' MSL.  
**Rwy 18**, electrical system 10' from DER, 80' right of centerline, 13' AGL/396' MSL.  
Vehicle on roadway 265' from DER, 420' right of centerline, 398' MSL.  
Vehicle on roadway 526' from DER, 17' left of centerline, 403' MSL.  
Building 560' from DER, 354' right of centerline, 21' AGL/403' MSL.  
Building 570' from DER, 632' right of centerline, 45' AGL/427' MSL.  
Building beginning 758' from DER, 137' right of centerline, up to 53' AGL/435' MSL.  
Tree 1595' from DER, 162' left of centerline, 51' AGL/433' MSL.  
Building 1929' from DER, 460' right of centerline, 66' AGL/447' MSL.  
Transmission line 4136' from DER, 1568' left of centerline, 132' AGL/513' MSL.  
**Rwy 22**, vertical structure, building beginning 142' from DER, 401' left of centerline, up to 18' AGL/401' MSL.  
Tower 165' from DER, 398' left of centerline, 45' AGL/429' MSL.  
**Rwy 27**, aircraft and hangars abeam DER, beginning 325' left of centerline, 40' AGL/455' MSL.  
Sign 389' from DER, 228' right of centerline, 21' AGL/401' MSL.  
Vehicles on roadway 422' from DER, 5' left of centerline, 395' MSL.  
Train on railroad tracks and power lines beginning 580' from DER, crossing centerline, up to 40' AGL/455' MSL.  
Pole 710' from DER, 251' right of centerline, 46' AGL/422' MSL.  
Tree 813' from DER, 88' right of centerline, 74' AGL/443' MSL.  
Tree 865' from DER, 255' right of centerline, 97' AGL/467' MSL.

CON'T

# TAKEOFF MINIMUMS, (OBSTACLE) DEPARTURE PROCEDURES, AND DIVERSE VECTOR AREA (RADAR VECTORS)

24025

EC-2



# TAKEOFF MINIMUMS, (OBSTACLE) DEPARTURE PROCEDURES, AND DIVERSE VECTOR AREA (RADAR VECTORS)

24025

## EVANSVILLE, IN (CON'T)

### EVANSVILLE RGNL (EVV) (CON'T)

**Rwy 27 (CON'T)**, tree 865' from DER, 149' left of centerline, 76' AGL/445' MSL.

Tree 891' from DER, 400' right of centerline, 102' AGL/471' MSL.

Tree 5649' from DER, 1389' left of centerline, 111' AGL/581' MSL.

Trees beginning 1 NM from DER, 856' left of centerline, up to 115' AGL/582' MSL.

Tower, tree, antenna beginning 1.2 NM from DER, 440' left of centerline, up to 175' AGL/688' MSL.

Tower 1.4 NM from DER, 2589' left of centerline, 181' AGL/649' MSL.

**Rwy 36**, trees, building beginning 2160' from DER, 479' right of centerline, up to 105' AGL/567' MSL.

Trees beginning 4224' from DER, 1024' right of centerline, up to 101' AGL/588' MSL.

Trees beginning 1 NM from DER, 1150' right of centerline, up to 104' AGL/599' MSL.

Tree 1 NM from DER, 1799' right of centerline, 126' AGL/608' MSL.

Trees beginning 1 NM from DER, 1776' right of centerline, up to 134' AGL/616' MSL.

Tree 1 NM from DER, 1915' right of centerline, 126' AGL/618' MSL.

Tree 1 NM from DER, 2035' right of centerline, 112' AGL/601' MSL.

## FINDLAY, OH

### FINDLAY (FDY)

#### TAKEOFF MINIMUMS AND (OBSTACLE) DEPARTURE PROCEDURES

AMDT 1 06DEC18 (18340) (FAA)

##### TAKEOFF MINIMUMS:

**Rwy 25**, 300-1% or std. w/min. climb of 210' per NM to 1100, or alternatively with std. takeoff minimums and a normal 200' per NM climb gradient, takeoff must occur no later than 1400 feet prior to DER.

##### TAKEOFF OBSTACLE NOTES:

**Rwy 7**, road with vehicles beginning 55' from DER, 308' right of centerline, up to 15' AGL/821' MSL.

Wall, pole beginning 121' from DER, 48' left of centerline, up to 10' AGL/816' MSL.

Tree, road with vehicles, pole beginning 154' from DER, 69' right of centerline, up to 32' AGL/838' MSL.

Road with vehicles beginning 210' from DER, 1' left of centerline, up to 15' AGL/821' MSL.

Trees beginning 279' from DER, 45' right of centerline, up to 33' AGL/839' MSL.

Tree, pole, building beginning 338' from DER, 33' left of centerline, up to 26' AGL/832' MSL.

Tree 1715' from DER, 959' right of centerline, 54' AGL/860' MSL.

Trees beginning 1846' from DER, 407' right of centerline, up to 64' AGL/870' MSL.

Building 2374' from DER, 1054' right of centerline, 110' AGL/916' MSL.

Building, tree, wind indicator beginning 2417' from DER, 109' right of centerline, up to 121' AGL/927' MSL.

**Rwy 18**, tree 2786' from DER, 150' left of centerline, 876' MSL.

**Rwy 25**, fence, vegetation beginning 26' from DER, 141' left of centerline, up to 6' AGL/799' MSL.

Road with vehicles beginning 133' from DER, 108' right of centerline, up to 15' AGL/803' MSL.

Sign, tree, pole beginning 473' from DER, 421' right of centerline, up to 64' AGL/852' MSL.

Tree, pole, road with vehicles beginning 785' from DER, 397' right of centerline, up to 15' AGL/802' MSL.

Elevator, tree beginning 1824' from DER, 295' right of centerline, up to 78' AGL/869' MSL.

Trees beginning 2207' from DER, 454' right of centerline, up to 88' AGL/876' MSL.

Elevator 1.2 NM from DER, 1040' right of centerline, 206' AGL/999' MSL.

Elevator 1.3 NM from DER, 1114' right of centerline, 207' AGL/1000' MSL.

**Rwy 36**, pole 1191' from DER, 742' right of centerline, 39' AGL/835' MSL.

Tree 1559' from DER, 498' left of centerline, 51' AGL/847' MSL.

## FORT WAYNE, IN

### FORT WAYNE INTL (FWA)

#### TAKEOFF MINIMUMS AND (OBSTACLE) DEPARTURE PROCEDURES

AMDT 3 17SEP15 (15260) (FAA)

##### TAKEOFF OBSTACLE NOTES:

**Rwy 5**, lighted structures beginning 9' from DER, left and right of centerline, up to 3' AGL/800' MSL.

Fence and trees beginning 152' from DER, 521' right of centerline, up to 42' AGL/842' MSL.

Railroad 834' from DER, 582' right of centerline, 23' AGL/820' MSL.

Trees beginning 927' from DER, 499' left of centerline, 40' AGL/836' MSL.

**Rwy 9**, lighted structures beginning 11' from DER, left and right of centerline, up to 2' AGL/794' MSL.

Pole 86' from DER, 442' right of centerline, 28' AGL/820' MSL.

Pole 380' from DER, 505' right of centerline, 32' AGL/822' MSL.

Tower 3124' from DER, 1109' left of centerline, 111' AGL/910' MSL.

**Rwy 14**, lighted structures beginning 9' from DER, left and right of centerline, up to 2' AGL/797' MSL.

Tree 1079' from DER, 667' left of centerline, 23' AGL/825' MSL.

**Rwy 23**, lighted structures beginning 8' from DER, left and right of centerline, up to 2' AGL/815' MSL.

**Rwy 27**, lighted structures beginning 9' from DER, 48' left of centerline, up to 2' AGL/800' MSL.

fences beginning 28' from DER, 470' right of centerline, up to 6' AGL/804' MSL.

Tower 194' from DER, 523' left of centerline, 19' AGL/809' MSL.

Obstruction light 370' from DER, 230' left of centerline, 14' AGL/812' MSL.

Trees beginning 3587' from DER, left and right of centerline, up to 104' AGL/910' MSL.

**Rwy 32**, lighted structures beginning 9' from DER, left and right of centerline, up to 2' AGL/803' MSL.

Trees beginning 3672' from DER, 611' left of centerline, up to 100' AGL/901' MSL.

# TAKEOFF MINIMUMS, (OBSTACLE) DEPARTURE PROCEDURES, AND DIVERSE VECTOR AREA (RADAR VECTORS)

24025

EC-2

22 FEB 2024 to 21 MAR 2024

22 FEB 2024 to 21 MAR 2024

# TAKEOFF MINIMUMS, (OBSTACLE) DEPARTURE PROCEDURES, AND DIVERSE VECTOR AREA (RADAR VECTORS)

24025

## FORT WAYNE, IN (CON'T)

SMITH FLD (SMD)

TAKEOFF MINIMUMS AND (OBSTACLE) DEPARTURE PROCEDURES

AMDT 5 18NOV10 (21168) (FAA)

TAKEOFF MINIMUMS:

**Rwy 23**, 800-3 or std. w/min. climb of 420' per NM to 1900.

DEPARTURE PROCEDURE:

**Rwy 13**, climb on heading between 133° CW to 185° from DER or climb on heading between 313° CW to 133° from DER to 2700 before proceeding on course or min. climb of 250' per NM to 2000 for all other courses.**Rwy 23**, climb on heading 236° to 1900 before proceeding on course.**Rwy 31**, climb on heading between 313° CW to 133° from DER or climb on heading between 250° CW to 313° from DER to 2700 before proceeding on course or min. climb of 250' per NM to 1900 for all other courses.

TAKEOFF OBSTACLE NOTES:

**Rwy 5**, vehicle on road 465' from DER, on centerline, 15' AGL/844' MSL.

Trees, light poles, flag poles, power poles, buildings, bus garages and cell tower beginning 345' from DER, 34' right of centerline, up to 153' AGL/974' MSL.

Trees, buildings and light poles beginning 234' from DER, 11' left of centerline, up to 72' AGL/896' MSL.

**Rwy 13**, vehicle on road 458' from DER, on centerline, 15' AGL/842' MSL.**Rwy 31**, trees and light pole beginning 21' from DER, 38' right of centerline, up to 100' AGL/929' MSL.

Trees, buildings, power poles, hanger, terminal, light pole and flag pole beginning 330' from DER, 25' left of centerline, up to 128' AGL/936' MSL.

**Rwy 23**, power poles, light poles, trees, building, house and shed beginning 469' from DER, 6' right of centerline, up to 82' AGL/909' MSL.

Trees, houses and light poles beginning 193' from DER, 43' left of centerline, up to 81' AGL/906' MSL.

**Rwy 31**, trees, buildings, power poles, garages, light pole and antenna beginning 237' from DER, 30' right of centerline, up to 95' AGL/936' MSL.

Trees and vert tank beginning 488' from DER, 202' left of centerline, up to 73' AGL/910' MSL.

## FOSTORIA, OH

FOSTORIA METRO (FZI)

TAKEOFF MINIMUMS AND (OBSTACLE) DEPARTURE PROCEDURES

AMDT 1 03JUN10 (21280) (FAA)

TAKEOFF OBSTACLE NOTES:

**Rwy 9**, trees beginning 343' from DER, 584' left of centerline, up to 74' AGL/823' MSL.

Trees beginning 26' from DER, 277' right of centerline, up to 75' AGL/820' MSL.

**Rwy 27**, trees beginning 938' from DER, 342' left of centerline, up to 100' AGL/859' MSL.

Trees beginning 379' from DER, 444' right of centerline, up to 64' AGL/806' MSL.

Building 2' from DER, 500' left of centerline, 8' AGL/758' MSL.

Building 262' from DER, 523' right of centerline, 34' AGL/776' MSL.

SILO 292' from DER, 376' right of centerline, 36' AGL/778' MSL.

Pole 898' from DER, 413' right of centerline, 39' AGL/778' MSL.

Power pole 961' from DER, 562' right of centerline, 48' AGL/790' MSL.

## FRANKFORT, IN

FRANKFORT CLINTON COUNTY RGNL (FKR)

TAKEOFF MINIMUMS AND (OBSTACLE) DEPARTURE PROCEDURES

ORIG 03JUN10 (22083) (FAA)

TAKEOFF OBSTACLE NOTES:

**Rwy 4**, vehicles on highway, beginning 148' from DER, left to right of centerline, 17' AGL/894' MSL.

Building 442' from DER, 601' right of centerline, 40' AGL/897' MSL.

Building 606' from DER, 373' left of centerline, 40' AGL/917' MSL.

Plant 3169' from DER, 712' right of centerline, 87' AGL/942' MSL.

**Rwy 9**, crops 389' from DER, left to right of centerline, 10' AGL/872' MSL.**Rwy 22**, crops 200' from DER, left to right of centerline, 10' AGL/867' MSL.

Vehicles on roadway beginning 369' from DER, 583' right of centerline, 17' AGL/876' MSL.

**Rwy 27**, crops 299' from DER, left to right of centerline, 10' AGL/867' MSL.

Vehicles on roadway 743' from DER, left and right of centerline, 17' AGL/876' MSL.

## FREMONT, OH

FREMONT (14G)

TAKEOFF MINIMUMS AND (OBSTACLE) DEPARTURE PROCEDURES

AMDT 2 22OCT09 (09295) (FAA)

TAKEOFF MINIMUMS:

**Rwys 18,36**, NA-Environmental.

TAKEOFF OBSTACLE NOTES:

**Rwy 9**, train 268' from DER, 516' right of centerline, 23' AGL/677' MSL.

Trees beginning 3269' from DER, 1265' right of centerline, up to 100' AGL/754' MSL.

Multiple trees and buildings beginning 320' from DER, left and right of centerline, up to 100' AGL/749' MSL.

**Rwy 27**, road 65' from DER, 4' right of centerline, 15' AGL/669' MSL.

Trees beginning 2230' from DER, 834' left of centerline, up to 100' AGL/754' MSL.

# TAKEOFF MINIMUMS, (OBSTACLE) DEPARTURE PROCEDURES, AND DIVERSE VECTOR AREA (RADAR VECTORS)

24025

EC-2

# TAKEOFF MINIMUMS, (OBSTACLE) DEPARTURE PROCEDURES, AND DIVERSE VECTOR AREA (RADAR VECTORS)

24025

## FREMONT, OH (CON'T)

SANDUSKY COUNTY RGNL (S24)

TAKEOFF MINIMUMS AND (OBSTACLE) DEPARTURE PROCEDURES

ORIG 25AUG11 (11237) (FAA)

TAKEOFF OBSTACLE NOTES:

**Rwy 6**, REILs 39' from DER, 93' right of centerline, 8' AGL/659' MSL.

REILs 39' from DER, 93' left of centerline, 7' AGL/658' MSL.

Trees beginning 796' from DER, 709' left of centerline, up to 91' AGL/737' MSL.

**Rwy 24**, REILs 41' from DER, 94' right of centerline, 7' AGL/668' MSL.

REILs 41' from DER, 93' left of centerline, 7' AGL/668' MSL.

Trees beginning 1569' from DER, left and right of centerline, up to 145' AGL/786' MSL.

## FRENCH LICK, IN

FRENCH LICK MUNI (FRH)

TAKEOFF MINIMUMS AND (OBSTACLE) DEPARTURE PROCEDURES

ORIG 10APR08 (08101) (FAA)

TAKEOFF OBSTACLE NOTES:

**Rwy 8**, terrain 59' from DER, 86' left of centerline, 0' AGL/799' MSL.

Trees beginning 184' from DER, 391' left of centerline, up to 100' AGL/889' MSL.

Trees beginning 215' from DER, 148' right of centerline, up to 100' AGL/849' MSL.

**Rwy 26**, trees beginning 429' from DER, 90' left of centerline, up to 100' AGL/849' MSL.

Trees beginning 580' from DER, 57' right of centerline, up to 100' AGL/909' MSL.

## GALION, OH

GALION MUNI (GQQ)

TAKEOFF MINIMUMS AND (OBSTACLE) DEPARTURE PROCEDURES

ORIG 25AUG11 (11237) (FAA)

TAKEOFF OBSTACLE NOTES:

**Rwy 5**, trees beginning 354' from DER, 335' right of centerline, up to 50' AGL/1269' MSL.**Rwy 23**, vehicles on road beginning 0' from DER, 348' right of centerline, up to 15' AGL/1244' MSL.

Vehicles on road beginning 0' from DER, 362' left of centerline, up to 17' AGL/1236' MSL.

Train and power lines 0' from DER, 351' left of centerline, up to 30' AGL/1252' MSL.

Trees beginning 341' from DER, right and left of centerline, up to 50' AGL/1279' MSL.

## GALLIPOLIS, OH

GALLIA-MEIGS RGNL (GAS)

TAKEOFF MINIMUMS AND (OBSTACLE) DEPARTURE PROCEDURES

AMDT 3 20JUN19 (19171) (FAA)

TAKEOFF MINIMUMS:

**Rwy 5**, 400-2½ or std. w/min. climb of 465' per NM to 1300.**Rwy 23**, 300-1 w/min. climb of 350' per NM to 1600 or std. w/min. climb of 460' per NM to 1300 or 1300-3 for VCOA.

DEPARTURE PROCEDURE:

**Rwy 5**, climb heading 55° to 1800 before proceeding on course.**Rwy 23**, climb heading 235° to 1200 before proceeding on course.

VCOA:

**Rwy 23**, obtain ATC approval for VCOA when requesting IFR clearance. Climb in visual conditions to cross Gallia-Meigs

Regional airport at or above 1700 before proceeding on course.

TAKEOFF OBSTACLE NOTES:

**Rwy 5**, vehicle on road 5' from DER, 391' left of centerline, 17' AGL/586' MSL.

Tree and power poles beginning 72' from DER, 388' right of centerline, up to 100' AGL/669' MSL.

Tree, sign, light pole beginning 99' from DER, 326' left of centerline, up to 100' AGL/659' MSL.

Tree 293' from DER, 409' right of centerline, 100' AGL/669' MSL.

Trees beginning 426' from DER, 346' right of centerline, up to 100' AGL/669' MSL.

Trees, light pole, vehicle on road beginning 438' from DER, 267' left of centerline, up to 100' AGL/669' MSL.

Vehicle on road 935' from DER, on and left of centerline, 17' AGL/586' MSL.

Tree and vehicle on overpass beginning 937' from DER, 440' left of centerline, up to 100' AGL/669' MSL.

Sign 1124' from DER, 285' right of centerline, 30' AGL/599' MSL.

Trees beginning 1297' from DER, 113' right of centerline, up to 100' AGL/669' MSL.

Trees beginning 1.5 NM from DER, 1270' right of centerline, up to 940' MSL.

**Rwy 23**, vehicles on road, train beginning 2' from DER, 207' right of centerline, up to 15' AGL/594' MSL.

Trees beginning 4' from DER, 451' left of centerline, up to 100' AGL/669' MSL.

Power poles, train 90' from DER, 407' right of centerline, up to 30' AGL/599' MSL.

Vehicles on road beginning 179' from DER, on and left of centerline, up to 15' AGL/575' MSL.

Tree 187' from DER, 424' left of centerline, 100' AGL/669' MSL.

Vehicle on road 551' from DER, 70' left of centerline, 15' AGL/575' MSL.

Buildings beginning 923' from DER, 220' left of centerline, up to 40' AGL/609' MSL.

Power poles, tank, tree beginning 1238' from DER, 510' left of centerline, up to 50' AGL/619' MSL.

Trees beginning 2322' from DER, 1074' right of centerline, up to 100' AGL/699' MSL.

22 FEB 2024 to 21 MAR 2024

22 FEB 2024 to 21 MAR 2024

# TAKEOFF MINIMUMS, (OBSTACLE) DEPARTURE PROCEDURES, AND DIVERSE VECTOR AREA (RADAR VECTORS)

24025

EC-2

# TAKEOFF MINIMUMS, (OBSTACLE) DEPARTURE PROCEDURES, AND DIVERSE VECTOR AREA (RADAR VECTORS)

24025

## GARY, IN

### GARY/CHICAGO INTL (GYY)

#### TAKEOFF MINIMUMS AND (OBSTACLE) DEPARTURE PROCEDURES

AMDT 8 25JUN15 (15176) (FAA)

##### TAKEOFF MINIMUMS:

**Rwy 2**, 300-1½ or std. with min. climb of 323' per NM to 900.

##### DEPARTURE PROCEDURE:

**Rwy 20**, climb heading 203° to 1300 before proceeding on course.

##### TAKEOFF OBSTACLE NOTES:

**Rwy 2**, tree, pole, building and vehicles on road beginning 554' from DER, 264' right of centerline, up to 26' AGL/617' MSL. Tower 3432' from DER, 1125' right of centerline, 120' AGL/708' MSL.

Stacks and towers beginning 4434' from DER, 1004' right of centerline, up to 201' AGL/791' MSL.

Tree 1489' from DER, 236' left of centerline, 56' AGL/647' MSL.

Towers beginning 4598' from DER, 1080' left of centerline, up to 139' AGL/731' MSL.

Stacks and tower beginning 5921' from DER, 460' left of centerline, up to 236' AGL/823' MSL.

Vehicles on road 571' from DER, on runway centerline, 15' AGL/605' MSL.

**Rwy 12**, trees and poles beginning 790' from DER, 221' right of centerline, up to 86' AGL/685' MSL.

trees beginning 1617' from DER, 743' left of centerline, up to 65' AGL/656' MSL.

Towers beginning 4246' from DER, 444' left of centerline, up to 105' AGL/700' MSL.

**Rwy 20**, trees and poles beginning 651' from DER, 108' right of centerline, up to 96' AGL/685' MSL.

Trees, poles and vehicles on road beginning 884' from DER, 26' left of centerline, up to 63' AGL/658' MSL.

Vehicles on road 1048' from DER, on runway centerline, 17' AGL/631' MSL.

**Rwy 30**, tree and poles beginning 2021' from DER, 390' right of centerline, up to 105' AGL/710' MSL.

Terrain 137' from DER, 351' left of centerline, 22' AGL/612' MSL.

Poles and road sign beginning 1263' from DER, 60' left of centerline, up to 49' AGL/638' MSL.

## GEORGETOWN, OH

### BROWN COUNTY (GEO)

#### TAKEOFF MINIMUMS AND (OBSTACLE) DEPARTURE PROCEDURES

AMDT 2 26AUG10 (10238) (FAA)

##### TAKEOFF OBSTACLE NOTES:

**Rwy 18**, vehicle on road beginning 430' from DER, 116' right of centerline, up to 15' AGL/974' MSL.

Vehicle on road beginning 400' from DER, 155' left of centerline, up to 15' AGL/974' MSL.

**Rwy 36**, trees 328' from DER, 232' right of centerline, up to 100' AGL/1059' MSL.

Trees 301' from DER, 452' left of centerline, up to 100' AGL, 1069' MSL.

## GOSHEN, IN

### GOSHEN MUNI (GSH)

#### TAKEOFF MINIMUMS AND (OBSTACLE) DEPARTURE PROCEDURES

ORIG-A 24MAY18 (18144) (FAA)

##### TAKEOFF MINIMUMS:

**Rwys 5, 23**, NA - environmental.

##### TAKEOFF OBSTACLE NOTES:

**Rwy 9**, post 42' from DER, 251' right of centerline, 12' AGL/831' MSL.

Pole 1030' from DER, 619' right of centerline, 37' AGL/862' MSL.

Pole 986' from DER, 465' left of centerline, 30' AGL/855' MSL.

Trees beginning 2493' from DER, 515' left of centerline, up to 100' AGL/966' MSL.

**Rwy 27**, trees beginning 2173' from DER, 210' right of centerline, up to 100' AGL/914' MSL.

Trees beginning 2072' from DER, 124' left of centerline, up to 100' AGL/914' MSL.

## GREENCASTLE, IN

### PUTNAM COUNTY RGNL (GPC)

#### TAKEOFF MINIMUMS AND (OBSTACLE) DEPARTURE PROCEDURES

AMDT 1 05JAN17 (17005) (FAA)

##### TAKEOFF OBSTACLE NOTES:

**Rwy 18**, grd 91' from DER, 299' left of centerline, 817' MSL.

Fence 113' from DER, 306' left of centerline, 3' AGL/822' MSL.

Fence 199' from DER, 307' left of centerline, 7' AGL/825' MSL.

Trees, poles, and bldgs beginning 538' from DER, 373' right of centerline, up to 973' MSL.

Tree 997' from DER, 266' left of centerline, 855' MSL.

Tree 1015' from DER, 360' left of centerline, 859' MSL.

Tree 2728' from DER, 1049' right of centerline, 894' MSL.

**Rwy 36**, grd 4' from DER, 486' right of centerline, 850' MSL.

Trees beginning 656' from DER, 596' right of centerline, up to 910' MSL.

Trees and bldg beginning 1269' from DER, 206' right of centerline, up to 912' MSL.

Trees, spire, and bldg beginning 1861' from DER, 217' right of centerline, up to 67' AGL/918' MSL.

Tree 1862' from DER, 535' left of centerline, 42' AGL/889' MSL.

Trees beginning 2227' from DER, 199' left of centerline, up to 64' AGL/912' MSL.

Tree and bldg beginning 2334' from DER, 18' left of centerline, up to 913' MSL.

# TAKEOFF MINIMUMS, (OBSTACLE) DEPARTURE PROCEDURES, AND DIVERSE VECTOR AREA (RADAR VECTORS)

24025

EC-2

# TAKEOFF MINIMUMS, (OBSTACLE) DEPARTURE PROCEDURES, AND DIVERSE VECTOR AREA (RADAR VECTORS)

24025

## GREENSBURG, IN

GREENSBURG MUNI (I34)

TAKEOFF MINIMUMS AND (OBSTACLE) DEPARTURE PROCEDURES

AMDT 1A 09APR09 (09099) (FAA)

TAKEOFF MINIMUMS:

**Rwy 36**, 300-1.

## GRIFFITH, IN

GRIFFITH-MERRILLVILLE (05C)

TAKEOFF MINIMUMS AND (OBSTACLE) DEPARTURE PROCEDURES

AMDT 4B 07OCT21 (21280) (FAA)

TAKEOFF MINIMUMS:

**Rwy 8**, 300-1.

TAKEOFF OBSTACLE NOTES:

**Rwy 8**, tree, pole, vehicles on road beginning 164' from DER, 135' right of centerline, up to 703' MSL.

Pole 307' from DER, 514' left of centerline, 44' AGL/675' MSL.

Tree, vehicles on road beginning 432' from DER, 169' left of centerline, up to 695' MSL.

Trees beginning 444' from DER, 6' right of centerline, up to 708' MSL.

Pole, building beginning 454' from DER, 191' left of centerline, up to 75' AGL/704' MSL.

Tree, pole beginning 831' from DER, 7' left of centerline, up to 712' MSL.

Trees beginning 1055' from DER, 5' right of centerline, up to 709' MSL.

Trees beginning 1980' from DER, 58' left of centerline, up to 717' MSL.

Tree 2967' from DER, 388' right of centerline, 714' MSL.

Trees beginning 3166' from DER, 259' left of centerline, up to 718' MSL.

Trees beginning 3288' from DER, 153' left of centerline, up to 724' MSL.

Tree 3747' from DER, 284' left of centerline, 726' MSL.

Tower 4136' from DER, 1383' left of centerline, 257' AGL/896' MSL.

Tower 4426' from DER, 1293' left of centerline, 148' AGL/791' MSL.

**Rwy 26**, vegetation 164' from DER, 471' left of centerline, 653' MSL.

Building 192' from DER, 156' right of centerline.

Pole 1247' from DER, 199' right of centerline, 40' AGL/675' MSL.

Tree 1286' from DER, 285' left of centerline, 667' MSL.

Tree, pole beginning 1298' from DER, 58' right of centerline, up to 693' MSL.

Tree, pole beginning 1380' from DER, 25' left of centerline, up to 703' MSL.

Tree 1498' from DER, 80' right of centerline, 703' MSL.

Tree 1523' from DER, 271' left of centerline, 709' MSL.

Pole, tree beginning 1590' from DER, 21' left of centerline, up to 75' AGL/713' MSL.

Trees beginning 1613' from DER, 93' right of centerline, up to 710' MSL.

Trees beginning 1739' from DER, 25' left of centerline, up to 723' MSL.

Trees beginning 1826' from DER, 60' right of centerline, up to 716' MSL.

Trees beginning 1920' from DER, 68' right of centerline, up to 717' MSL.

Trees beginning 2144' from DER, 12' right of centerline, up to 739' MSL.

Tree 3205' from DER, 716' left of centerline, 725' MSL.

## HAMILTON, OH

BUTLER COUNTY RGNL/HOGAN FLD (HAO)

TAKEOFF MINIMUMS AND (OBSTACLE) DEPARTURE PROCEDURES

AMDT 5 03JAN19 (21280) (FAA)

TAKEOFF MINIMUMS:

**Rwy 29**, 300-1 or std. w/min. climb of 482' per NM to 900.

DEPARTURE PROCEDURE:

**Rwy 11**, climb heading 125° to 1700 before proceeding on course.

TAKEOFF OBSTACLE NOTES:

**Rwy 11**, tree 939' from DER, 750' right of centerline, 667' MSL.

Pole 2962' from DER, 617' left of centerline, 29' AGL/694' MSL.

Pole 3320' from DER, 614' left of centerline, 53' AGL/706' MSL.

Pole 3559' from DER, 167' left of centerline, 62' AGL/711' MSL.

Tree 3624' from DER, 128' right of centerline, 717' MSL.

**Rwy 29**, vegetation 155' from DER, 277' right of centerline, 641' MSL.

Building 533' from DER, 374' left of centerline, 29' AGL/657' MSL.

Tree 964' from DER, 416' right of centerline, 667' MSL.

Tree 1123' from DER, 722' left of centerline, 698' MSL.

Tree 1395' from DER, 758' left of centerline, 702' MSL.

Vehicle on road, trees beginning 1946' from DER, 243' right of centerline, up to 703' MSL.

Pole 2217' from DER, 422' right of centerline, 22' AGL/721' MSL.

Tree, building beginning 2243' from DER, 370' right of centerline, up to 782' MSL.

Tree 2580' from DER, 269' left of centerline, 705' MSL.

Trees beginning 2595' from DER, 104' right of centerline, up to 788' MSL.

Trees beginning 2667' from DER, 57' left of centerline, up to 723' MSL.

Trees beginning 3548' from DER, 241' right of centerline, up to 814' MSL.

# TAKEOFF MINIMUMS, (OBSTACLE) DEPARTURE PROCEDURES, AND DIVERSE VECTOR AREA (RADAR VECTORS)

24025

# TAKEOFF MINIMUMS, (OBSTACLE) DEPARTURE PROCEDURES, AND DIVERSE VECTOR AREA (RADAR VECTORS)

24025

## HARRISON, OH

### CINCINNATI WEST (I67)

#### TAKEOFF MINIMUMS AND (OBSTACLE) DEPARTURE PROCEDURES

AMDT 2A 08OCT20 (20282) (FAA)

##### TAKEOFF MINIMUMS:

**Rwy 1**, 500-3 or std. w/min. climb of 385' per NM to 1200.

**Rwy 19**, 500-3 or std. w/min. climb of 253' per NM to 1300.

##### TAKEOFF OBSTACLE NOTES:

**Rwy 1**, multiple trees beginning 5364' from DER, 180' right of centerline, up to 100' AGL/915' MSL.

Multiple trees beginning 5596' from DER, 1180' left of centerline up to 100' AGL/909' MSL.

Multiple trees beginning 1.5 NM from DER, 2293' left of centerline, up to 200' AGL/849' MSL.

**Rwy 19**, road 23' from DER, on centerline, 15' AGL/599' MSL.

## HILLSBORO, OH

### HIGHLAND COUNTY (HOC)

#### TAKEOFF MINIMUMS AND (OBSTACLE) DEPARTURE PROCEDURES

AMDT 4 19JUL18 (18200) (FAA)

##### TAKEOFF MINIMUMS:

**Rwy 5**, 300-1¼ or std. w/min. climb of 285' per NM to 1300.

##### DEPARTURE PROCEDURES:

**Rwy 23**, climb on heading 234° to 1600 before turning left.

##### TAKEOFF OBSTACLE NOTES:

**Rwy 5**, trees beginning 20' from DER, 40' left of centerline, up to 1023' MSL.

Fence 105' from DER, 326' right of centerline, 9' AGL/952' MSL.

Trees beginning 145' from DER, 13' right of centerline, up to 1023' MSL.

Tree 4652' from DER, 205' right of centerline, 1051' MSL.

Trees beginning 4692' from DER, 31' right of centerline, up to 100' AGL/1078' MSL.

Tree 1.1 NM from DER, 2294' right of centerline, 100' AGL/1170' MSL.

**Rwy 23**, tree 49' from DER, 444' right of centerline, 999' MSL.

Trees beginning 90' from DER, 185' right of centerline, up to 100' AGL/1075' MSL.

Tree, pole beginning 109' from DER, 42' left of centerline, up to 100' AGL/1062' MSL.

Trees beginning 448' from DER, 109' right of centerline, up to 100' AGL/1081' MSL.

Trees beginning 627' from DER, 33' right of centerline, up to 100' AGL/1085' MSL.

## HUNTINGBURG, IN

### HUNTINGBURG (HNB)

#### TAKEOFF MINIMUMS AND (OBSTACLE) DEPARTURE PROCEDURES

AMDT 2 12AUG21 (21224) (FAA)

##### TAKEOFF OBSTACLE NOTES:

**Rwy 9**, tree 1255' from DER, 507' left of centerline, 76' AGL/567' MSL.

Trees beginning 1257' from DER, 544' left of centerline, up to 90' AGL/584' MSL.

Tree 1558' from DER, 763' left of centerline, 597' MSL.

Trees beginning 1643' from DER, 800' left of centerline, up to 604' MSL.

Trees beginning 1980' from DER, 901' left of centerline, up to 606' MSL.

Trees beginning 4445' from DER, 1257' right of centerline, up to 646' MSL.

Tree 4621' from DER, 978' left of centerline, 646' MSL.

Trees beginning 4648' from DER, 730' left of centerline, up to 654' MSL.

Tree 4824' from DER, 1677' right of centerline, 654' MSL.

Trees beginning 4854' from DER, 889' left of centerline, up to 666' MSL.

Tree 4894' from DER, 1561' right of centerline, 655' MSL.

Trees beginning 4998' from DER, 733' right of centerline, up to 660' MSL.

Trees beginning 5201' from DER, 696' right of centerline, up to 671' MSL.

Electrical system 5509' from DER, 592' left of centerline, 90' AGL/667' MSL.

**Rwy 27**, lighting 9' from DER, 16' right of centerline, 1' AGL/514' MSL.

Trees beginning 415' from DER, 465' right of centerline, up to 57' AGL/557' MSL.

Trees beginning 569' from DER, 500' right of centerline, up to 87' AGL/583' MSL.

Trees beginning 606' from DER, 613' right of centerline, up to 97' AGL/591' MSL.

Trees beginning 741' from DER, 511' right of centerline, up to 597' MSL.

Trees beginning 860' from DER, 333' left of centerline, up to 569' MSL.

Tree 1740' from DER, 764' left of centerline, 581' MSL.

Trees beginning 1970' from DER, 750' left of centerline, up to 587' MSL.

Tree 2805' from DER, 1215' left of centerline, 590' MSL.

22 FEB 2024 to 21 MAR 2024

22 FEB 2024 to 21 MAR 2024

# TAKEOFF MINIMUMS, (OBSTACLE) DEPARTURE PROCEDURES, AND DIVERSE VECTOR AREA (RADAR VECTORS)

24025

EC-2

# TAKEOFF MINIMUMS, (OBSTACLE) DEPARTURE PROCEDURES, AND DIVERSE VECTOR AREA (RADAR VECTORS)

24025

## HUNTINGTON, IN

### HUNTINGTON MUNI (HHG)

TAKEOFF MINIMUMS AND (OBSTACLE) DEPARTURE PROCEDURES  
AMDT 2A 27JAN22 (22027) (FAA)

#### TAKEOFF OBSTACLE NOTES:

- Rwy 10**, trees beginning 2' from DER, 59' right of centerline, up to 854' MSL.
- Pole 47' from DER, 198' left of centerline, 23' AGL/812' MSL.
- Trees beginning 291' from DER, 10' left of centerline, up to 882' MSL.
- Trees beginning 1006' from DER, 230' left of centerline, up to 892' MSL.
- Trees beginning 1142' from DER, 35' right of centerline, up to 866' MSL.
- Tree 2112' from DER, 509' right of centerline, 872' MSL.
- Rwy 28**, tree 112' from DER, 498' left of centerline, 855' MSL.
- Tree, vegetation, vehicles on road, pole beginning 159' from DER, 20' left of centerline, up to 875' MSL.
- Building 269' from DER, 519' right of centerline, 20' AGL/826' MSL.
- Pole, tree beginning 456' from DER, 31' right of centerline, up to 41' AGL/846' MSL.
- Tree, pole beginning 832' from DER, 2' right of centerline, up to 851' MSL.
- Tree 2727' from DER, 816' right of centerline, 900' MSL.

## INDIANAPOLIS, IN

### EAGLE CREEK AIRPARK (EYE)

TAKEOFF MINIMUMS AND (OBSTACLE) DEPARTURE PROCEDURES  
AMDT 3 31MAR16 (16091) (FAA)

#### DEPARTURE PROCEDURE:

- Rwy 3**, climb heading 031° to 2100 before turning on course.

#### TAKEOFF OBSTACLE NOTES:

- Rwy 3**, pole 507' from DER, 631' left of centerline, 38' AGL/860' MSL.
- Building 859' from DER, 524' right of centerline, 35' AGL/851' MSL.
- Trees beginning 2015' from DER, 583' left of centerline, up to 87' AGL/904' MSL.
- Rwy 21**, airport beacon 10' from DER, 464' left of centerline, 54' AGL/867' MSL.
- Pole 167' from DER, 385' left of centerline, 33' AGL/848' MSL.
- Vehicles on road 310' from DER, right and left of centerline, up to 15' AGL/833' MSL.
- Building 363' from DER, 258' left of centerline, 14' AGL/828' MSL.
- Trees beginning 677' from DER, 267' right of centerline, up to 89' AGL/901' MSL.
- Poles and power lines beginning 699' from DER, 451' left of centerline, up to 38' AGL/849' MSL.
- Trees beginning 1623' from DER, 57' left of centerline, up to 90' AGL/890' MSL.

## HENRICKS COUNTY-GORDON GRAHAM FLD (2R2)

TAKEOFF MINIMUMS AND (OBSTACLE) DEPARTURE PROCEDURES  
ORIG 05JUN08 (21280) (FAA)

#### TAKEOFF OBSTACLE NOTES:

- Rwy 18**, pole 746' from DER, on centerline, 60' AGL/919' MSL.
- Trees 2091' from DER, 625' left of centerline, 100' AGL/949' MSL.
- Rwy 36**, trees 1302' from DER, 648' right of centerline, 100' AGL/1009' MSL.
- Tree 3529' from DER, 788' right of centerline, 100' AGL/1009' MSL.
- Tree 5244' from DER, 1005' left of centerline, 100' AGL/1029' MSL.

## INDIANAPOLIS EXEC (TYQ)

TAKEOFF MINIMUMS AND (OBSTACLE) DEPARTURE PROCEDURES  
AMDT 2 05OCT23 (23278) (FAA)

#### TAKEOFF OBSTACLE NOTES:

- Rwy 18**, tree 212' from DER, 203' left of centerline, 40' AGL/954' MSL.
- Trees beginning 370' from DER, 247' left of centerline, up to 60' AGL/971' MSL.
- Trees beginning 1385' from DER, 752' left of centerline, up to 75' AGL/986' MSL.
- Tree 1541' from DER, 741' left of centerline, 78' AGL/990' MSL.
- Trees beginning 1568' from DER, 196' left of centerline, up to 79' AGL/993' MSL.
- Tree 1602' from DER, 622' right of centerline, 74' AGL/988' MSL.
- Trees beginning 1670' from DER, 192' left of centerline, up to 994' MSL.
- Trees beginning 1875' from DER, 733' right of centerline, up to 86' AGL/997' MSL.
- Trees beginning 1924' from DER, 251' right of centerline, up to 96' AGL/1007' MSL.
- Trees beginning 2031' from DER, 311' left of centerline, up to 996' MSL.
- Rwy 36**, wind indicator, building beginning 124' from DER, 429' left of centerline, up to 22' AGL/943' MSL.
- Pole 1115' from DER, 490' left of centerline, 26' AGL/951' MSL.
- Pole 1134' from DER, 321' left of centerline, 33' AGL/958' MSL.
- Poles beginning 1144' from DER, 326' left of centerline, up to 961' MSL.
- Poles beginning 1156' from DER, 336' right of centerline, up to 955' MSL, pole 1203' from DER, 776' right of centerline, 959' MSL.
- Trees beginning 1242' from DER, 55' left of centerline, up to 974' MSL.
- Trees beginning 1256' from DER, 320' right of centerline, up to 52' AGL/974' MSL.
- Trees beginning 1755' from DER, 318' right of centerline, up to 993' MSL.
- Trees beginning 1963' from DER, 779' left of centerline, up to 977' MSL.
- Trees beginning 2024' from DER, 22' right of centerline, up to 996' MSL.
- Trees beginning 2159' from DER, 25' left of centerline, up to 997' MSL.
- Tree 2853' from DER, 58' left of centerline, 74' AGL/999' MSL.

CON'T

# TAKEOFF MINIMUMS, (OBSTACLE) DEPARTURE PROCEDURES, AND DIVERSE VECTOR AREA (RADAR VECTORS)

24025

EC-2

# TAKEOFF MINIMUMS, (OBSTACLE) DEPARTURE PROCEDURES, AND DIVERSE VECTOR AREA (RADAR VECTORS)

24025

## INDIANAPOLIS, IN (CON'T)

### INDIANAPOLIS EXEC (TYQ) (CON'T)

**Rwy 36 (CON'T)**, tree 2880' from DER, 88' left of centerline, 74' AGL/1000' MSL.  
Trees beginning 2887' from DER, 21' left of centerline, up to 79' AGL/1004' MSL.  
Trees beginning 2955' from DER, 22' left of centerline, up to 80' AGL/1005' MSL.  
Trees beginning 2957' from DER, 4' left of centerline, up to 84' AGL/1008' MSL.  
Tree 2966' from DER, 129' right of centerline, 75' AGL/1001' MSL.  
Tree 2988' from DER, 332' left of centerline, 97' AGL/1011' MSL.  
Trees beginning 2999' from DER, 5' left of centerline, up to 105' AGL/1018' MSL.  
Tree 3045' from DER, 185' right of centerline, 77' AGL/1003' MSL.  
Tree 3055' from DER, 167' right of centerline, 79' AGL/1004' MSL.  
Trees beginning 3058' from DER, 18' right of centerline, up to 87' AGL/1011' MSL.  
Trees beginning 3179' from DER, 16' left of centerline, up to 106' AGL/1020' MSL.  
Trees beginning 3193' from DER, 1' left of centerline, up to 109' AGL/1022' MSL.  
Trees beginning 3259' from DER, 24' right of centerline, up to 99' AGL/1018' MSL.  
Trees beginning 3318' from DER, 7' right of centerline, up to 103' AGL/1023' MSL.  
Trees beginning 3355' from DER, 4' right of centerline, up to 107' AGL/1026' MSL.  
Trees beginning 3403' from DER, 1' left of centerline, up to 1024' MSL.  
Trees beginning 3476' from DER, 4' right of centerline, up to 102' AGL/1028' MSL.  
Trees beginning 3506' from DER, 4' left of centerline, up to 111' AGL/1027' MSL.  
Trees beginning 3613' from DER, 8' right of centerline, up to 126' AGL/1036' MSL.  
Trees beginning 3755' from DER, 9' left of centerline, up to 1034' MSL.

## INDIANAPOLIS INTL (IND)

### TAKEOFF MINIMUMS AND (OBSTACLE) DEPARTURE PROCEDURES

ORIG 18JAN07 (07018) (FAA)

#### TAKEOFF OBSTACLE NOTES:

**Rwy 5R**, tower 3756' from DER, 1048' left of centerline, 111' AGL/901' MSL.  
Rod on obstruction light dome 3765' from DER, 1076' left of centerline, 107' AGL/901' MSL.  
**Rwy 5L**, rod on obstruction light MCWV tower 5052' from DER, 140' right of centerline, 129' AGL/923' MSL.  
Tower 5073' from DER, 93' right of centerline, 128' AGL/923' MSL.  
**Rwy 23R**, tree 5159' from DER, 1144' right of centerline, 101' AGL/870' MSL.  
Tree 3295' from DER, 948' right of centerline, 78' AGL/822' MSL.  
**Rwy 32**, antenna 2370' from DER, 755' right of centerline, 70' AGL/849' MSL.  
Tree 2244' from DER, 707' right of centerline, 66' AGL/845' MSL.

## INDIANAPOLIS METRO (UMP)

### TAKEOFF MINIMUMS AND (OBSTACLE) DEPARTURE PROCEDURES

AMDT 3 05MAY11 (22083) (FAA)

#### TAKEOFF MINIMUMS:

**Rwy 15**, NA-Obstacles.

#### DEPARTURE PROCEDURE:

**Rwy 33**, climb heading 329° to 1400 before turning left.

#### TAKEOFF OBSTACLE NOTES:

**Rwy 33**, vehicles on road 367' from DER, crossing left and right of centerline, up to 15' AGL/799' MSL.  
Trees beginning 682' from DER, 69' right of centerline, up to 100' AGL/879' MSL.  
Trees beginning 1805' from DER, 648' left of centerline, up to 100' AGL/874' MSL.

## INDIANAPOLIS RGNL (MQJ)

### TAKEOFF MINIMUMS AND (OBSTACLE) DEPARTURE PROCEDURES

AMDT 3 20SEP12 (12264) (FAA)

#### TAKEOFF MINIMUMS:

**Rwy 34**, 300-1 or std. w/min. climb of 347' per NM to 1100.

#### DEPARTURE PROCEDURE:

**Rwy 25**, climb heading 270° to 2000 before turning left.

#### TAKEOFF OBSTACLE NOTES:

**Rwy 7**, airplane on taxiway, 177' from DER, 518' left of centerline, up to 17' AGL/871' MSL.  
Trees beginning 4074' from DER, 434' left of centerline, up to 100' AGL/969' MSL.  
Trees beginning 4626' from DER, 837' right of centerline, up to 100' AGL/979' MSL.  
**Rwy 16**, airplane on taxiway, 183' from DER, 479' right of centerline, up to 17' AGL/871' MSL.  
Pole 234' from DER, 550' right of centerline, 6' AGL/864' MSL.  
Trees beginning 1634' from DER, 666' left of centerline, up to 78' AGL/929' MSL.  
**Rwy 25**, trees beginning 2347' from DER, 927' left of centerline, up to 100' AGL/969' MSL.  
**Rwy 34**, trees beginning 1309' from DER, 7' left of centerline, up to 98' AGL/954' MSL.  
Pole 1587' from DER, 295' left of centerline, 41' AGL/900' MSL.  
Trees beginning 3099' from DER, 1043' right of centerline, up to 86' AGL/960' MSL.  
Antennas and towers beginning 3682' from DER, 1364' right of centerline, up to 167' AGL/1022' MSL.

# TAKEOFF MINIMUMS, (OBSTACLE) DEPARTURE PROCEDURES, AND DIVERSE VECTOR AREA (RADAR VECTORS)

24025

EC-2



# TAKEOFF MINIMUMS, (OBSTACLE) DEPARTURE PROCEDURES, AND DIVERSE VECTOR AREA (RADAR VECTORS)

24025

## INDIANAPOLIS, IN (CON'T)

### INDY SOUTH GREENWOOD (HFY)

#### TAKEOFF MINIMUMS AND (OBSTACLE) DEPARTURE PROCEDURES

AMDT 5 01FEB18 (18032) (FAA)

#### DEPARTURE PROCEDURE:

**Rwy 1**, climb heading 010° to 1500 before turning right.

#### TAKEOFF OBSTACLE NOTES:

**Rwy 1**, poles beginning 7' from DER, 224' left of centerline, up to 17' AGL/835' MSL.

Tree 41' from DER, 364' right of centerline, 26' AGL/846' MSL.

Building 105' from DER, 495' right of centerline, 27' AGL/848' MSL.

Building 430' from DER, 603' left of centerline, 37' AGL/857' MSL.

Building, tree, pole beginning 458' from DER, 378' right of centerline, up to 40' AGL/858' MSL.

Building, pole beginning 463' from DER, 562' left of centerline, up to 39' AGL/859' MSL.

Building, pole, tree beginning 506' from DER, 470' left of centerline, up to 45' AGL/865' MSL.

Pole 671' from DER, 464' right of centerline, 51' AGL/868' MSL.

Pole, traverse way, sign, building, tree beginning 690' from DER, 245' right of centerline, up to 53' AGL/872' MSL.

Transmission line, pole beginning 1555' from DER, 659' right of centerline, up to 70' AGL/893' MSL.

Trees beginning 1917' from DER, 321' left of centerline, up to 90' AGL/899' MSL.

Trees beginning 2026' from DER, 328' left of centerline, up to 103' AGL/907' MSL.

Tree, transmission line beginning 2328' from DER, 795' right of centerline, up to 76' AGL/894' MSL.

Tree, transmission line beginning 2463' from DER, 376' right of centerline, up to 77' AGL/898' MSL.

Building 5365' from DER, 1405' right of centerline, 135' AGL/957' MSL.

**Rwy 19**, terrain 2' from DER, 496' left of centerline, 824' MSL.

Fence 12' from DER, 490' right of centerline, 4' AGL/826' MSL.

Tree 212' from DER, 549' left of centerline, 52' AGL/873' MSL.

Tree 543' from DER, 417' right of centerline, 18' AGL/845' MSL.

Tree, building beginning 564' from DER, 612' left of centerline, up to 62' AGL/884' MSL.

Tree 638' from DER, 402' right of centerline, 20' AGL/849' MSL.

Tree 752' from DER, 383' right of centerline, 24' AGL/852' MSL.

Trees beginning 782' from DER, 65' right of centerline, up to 41' AGL/868' MSL.

Tree, pole beginning 953' from DER, 9' left of centerline, up to 62' AGL/886' MSL.

Tree, pole beginning 1155' from DER, 145' right of centerline, up to 69' AGL/896' MSL.

Trees beginning 1487' from DER, 83' right of centerline, up to 78' AGL/902' MSL.

Trees beginning 1561' from DER, 25' right of centerline, up to 76' AGL/904' MSL.

Trees beginning 2035' from DER, 270' right of centerline, up to 87' AGL/908' MSL.

Trees beginning 2161' from DER, 634' left of centerline, up to 76' AGL/908' MSL.

Trees beginning 2706' from DER, 156' left of centerline, up to 80' AGL/916' MSL.

Trees beginning 2730' from DER, 248' right of centerline, up to 98' AGL/923' MSL.

Tree 3079' from DER, 1113' left of centerline, 60' AGL/918' MSL.

Trees beginning 3080' from DER, 181' left of centerline, up to 64' AGL/921' MSL.

Trees beginning 3246' from DER, 131' left of centerline, up to 72' AGL/923' MSL.

Tree 4071' from DER, 127' left of centerline, 79' AGL/944' MSL.

## JACKSON, OH

### JAMES A RHODES (JRO)

#### TAKEOFF MINIMUMS AND (OBSTACLE) DEPARTURE PROCEDURES

AMDT 4A 14JUL22 (22195) (FAA)

#### TAKEOFF MINIMUMS:

**Rwy 1**, 300-1%.

**Rwy 19**, 300-1%.

#### DEPARTURE PROCEDURE:

**Rwy 1**, climb on heading 010° to 1500 before turning left.

#### TAKEOFF OBSTACLE NOTES:

**Rwy 1**, vehicle on road 104' from DER, 233' left of centerline, 748' MSL.

Trees, terrain, beginning 162' from DER, 186' left of centerline, up to 38' AGL/773' MSL.

Tree, terrain, vehicle on road, beginning 540' from DER, 234' left of centerline, up to 32' AGL/784' MSL.

Tree 763' from DER, 596' left of centerline, 51' AGL/806' MSL.

Trees, beginning 930' from DER, 431' right of centerline, up to 71' AGL/799' MSL.

Tree, vehicle on road, beginning 956' from DER, 237' left of centerline, up to 83' AGL/840' MSL.

Tree, vehicle on road, beginning 1138' from DER, 238' left of centerline, up to 84' AGL/843' MSL.

Trees, pole, transmission line, beginning 1286' from DER, 222' left of centerline, up to 94' AGL/864' MSL.

Trees, vehicle on road, poles, transmission line, beginning 1425' from DER, 224' left of centerline, up to 99' AGL/867' MSL.

Tree, terrain, beginning 1973' from DER, 599' left of centerline, up to 55' AGL/871' MSL.

Tree 2132' from DER, 568' left of centerline, 84' AGL/893' MSL.

Tree 2142' from DER, 997' left of centerline, 91' AGL/894' MSL.

Tree, terrain, beginning 2156' from DER, 343' left of centerline, up to 93' AGL/911' MSL.

Tree 2239' from DER, 589' left of centerline, 78' AGL/915' MSL.

Trees, pole, transmission line, terrain, beginning 2291' from DER, 249' left of centerline, up to 65' AGL/922' MSL.

Trees, vehicle on road, beginning 2453' from DER, 197' left of centerline, up to 71' AGL/931' MSL.

Trees, transmission line, pole, beginning 2590' from DER, 167' right of centerline, up to 71' AGL/810' MSL.

Trees, pole, beginning 2645' from DER, 283' left of centerline, up to 68' AGL/933' MSL.

Trees, pole, transmission line, building, sign, tower, beginning 2721' from DER, 106' left of centerline, up to 86' AGL/939' MSL.

Tree 2779' from DER, 25' right of centerline, 64' AGL/826' MSL.

CON'T

# TAKEOFF MINIMUMS, (OBSTACLE) DEPARTURE PROCEDURES, AND DIVERSE VECTOR AREA (RADAR VECTORS)

24025

EC-2

22 FEB 2024 to 21 MAR 2024

22 FEB 2024 to 21 MAR 2024

# TAKEOFF MINIMUMS, (OBSTACLE) DEPARTURE PROCEDURES, AND DIVERSE VECTOR AREA (RADAR VECTORS)

24025

## JACKSON, OH (CON'T)

### JAMES A RHODES (JRO) (CON'T)

**Rwy 1 (CON'T)**, trees, beginning 2800' from DER, 122' right of centerline, up to 76' AGL/833' MSL.  
 Trees, beginning 2863' from DER, 7' right of centerline, up to 93' AGL/845' MSL.  
 Trees, building, beginning 2866' from DER, 170' left of centerline, up to 75' AGL/945' MSL.  
 Trees, poles, beginning 2973' from DER, 32' left of centerline, up to 108' AGL/955' MSL.  
 Trees, beginning 3628' from DER, 681' right of centerline, up to 100' AGL/854' MSL.  
 Trees, beginning 3737' from DER, 547' right of centerline, up to 92' AGL/861' MSL.  
 Trees, beginning 4116' from DER, 487' right of centerline, up to 108' AGL/880' MSL.  
 Trees, beginning 4220' from DER, 11' left of centerline, up to 92' AGL/956' MSL.  
 Trees, beginning 4277' from DER, 673' right of centerline, up to 101' AGL/888' MSL.  
 Trees, beginning 4362' from DER, 7' right of centerline, up to 98' AGL/894' MSL.  
 Tree 4507' from DER, 279' right of centerline, 81' AGL/895' MSL.  
 Trees, beginning 4507' from DER, 369' right of centerline, up to 90' AGL/898' MSL.  
 Tree 4532' from DER, 524' right of centerline, 108' AGL/900' MSL.  
 Trees, beginning 4541' from DER, 278' right of centerline, up to 87' AGL/907' MSL.  
 Trees, beginning 4590' from DER, 16' right of centerline, up to 98' AGL/908' MSL.  
 Trees, beginning 4812' from DER, 74' right of centerline, up to 70' AGL/914' MSL.  
 Trees, beginning 5025' from DER, 65' right of centerline, up to 72' AGL/917' MSL.  
 Trees, beginning 5093' from DER, 40' left of centerline, up to 81' AGL/957' MSL.  
 Trees, beginning 5145' from DER, 14' left of centerline, up to 89' AGL/962' MSL.  
 Trees, beginning 5167' from DER, 72' left of centerline, up to 77' AGL/965' MSL.  
 Trees, poles, building, beginning 5259' from DER, 66' right of centerline, up to 80' AGL/919' MSL.  
 Trees, beginning 5348' from DER, 203' left of centerline, up to 82' AGL/968' MSL.  
 Trees, beginning 5417' from DER, 1003' left of centerline, up to 83' AGL/969' MSL.  
 Trees, transmission line, poles, building, beginning 5447' from DER, 70' left of centerline, up to 93' AGL/971' MSL.  
 Tree, pole, building, beginning 5481' from DER, 116' right of centerline, up to 73' AGL/934' MSL.  
 Trees, beginning 5819' from DER, 54' right of centerline, up to 109' AGL/936' MSL.  
 Trees, beginning 6037' from DER, 21' left of centerline, up to 95' AGL/973' MSL.  
 Transmission line, trees, beginning 1 NM from DER, 188' left of centerline, up to 138' AGL/1013' MSL.  
 Transmission line, trees, water towers, tank, beginning 1.1 NM from DER, 10' left of centerline, up to 171' AGL/1023' MSL.  
 Transmission line, trees, beginning 1.1 NM from DER, 75' right of centerline, up to 147' AGL/960' MSL.  
 Tree 1.5 NM from DER, 2581' left of centerline, 95' AGL/957' MSL.  
**Rwy 19**, terrain, beginning 3' from DER, 205' right of centerline, up to 725' MSL.  
 Tree, terrain, pole, building, beginning 774' from DER, 196' right of centerline, up to 60' AGL/817' MSL.  
 Terrain 792' from DER, 6' left of centerline, 746' MSL.  
 Trees, building, beginning 820' from DER, 476' right of centerline, up to 55' AGL/821' MSL.  
 Tree 863' from DER, 336' left of centerline, 30' AGL/752' MSL.  
 Trees, buildings, terrain, poles, vehicle on road, beginning 888' from DER, 3' right of centerline, up to 67' AGL/831' MSL.  
 Building 899' from DER, 280' left of centerline, 24' AGL/754' MSL.  
 Trees, stack, pole, beginning 914' from DER, 111' left of centerline, up to 62' AGL/800' MSL.  
 Trees, poles, beginning 1106' from DER, 113' left of centerline, up to 62' AGL/804' MSL.  
 Trees, poles, beginning 1418' from DER, 21' left of centerline, up to 89' AGL/810' MSL.  
 Trees, pole, beginning 1447' from DER, 194' right of centerline, up to 65' AGL/853' MSL.  
 Trees, terrain, buildings, beginning 1555' from DER, 45' right of centerline, up to 65' AGL/864' MSL.  
 Trees, poles, buildings, terrain, beginning 1736' from DER, 24' right of centerline, up to 87' AGL/878' MSL.  
 Tree 2233' from DER, 25' left of centerline, 73' AGL/830' MSL.  
 Trees, building, beginning 2266' from DER, 6' left of centerline, up to 78' AGL/836' MSL.  
 Trees, beginning 2817' from DER, 64' left of centerline, up to 94' AGL/857' MSL.  
 Trees, pole, beginning 2843' from DER, 27' left of centerline, up to 93' AGL/860' MSL.  
 Trees, beginning 3067' from DER, 186' right of centerline, up to 110' AGL/890' MSL.  
 Trees, beginning 3179' from DER, 183' right of centerline, up to 98' AGL/893' MSL.  
 Trees, beginning 3272' from DER, 193' right of centerline, up to 99' AGL/899' MSL.  
 Trees, beginning 3345' from DER, 462' right of centerline, up to 103' AGL/914' MSL.  
 Trees, beginning 3370' from DER, 364' right of centerline, up to 106' AGL/930' MSL.  
 Trees, beginning 3436' from DER, 198' right of centerline, up to 119' AGL/936' MSL.  
 Trees, beginning 3576' from DER, 175' right of centerline, up to 113' AGL/940' MSL.  
 Trees, beginning 3642' from DER, 193' right of centerline, up to 113' AGL/942' MSL.  
 Trees, beginning 3747' from DER, 188' right of centerline, up to 124' AGL/944' MSL.  
 Trees, beginning 3927' from DER, 146' right of centerline, up to 102' AGL/962' MSL.  
 Trees, building, beginning 4077' from DER, 12' right of centerline, up to 105' AGL/965' MSL.  
 Trees, beginning 4196' from DER, 817' left of centerline, up to 60' AGL/885' MSL.  
 Trees, beginning 4202' from DER, 305' left of centerline, up to 105' AGL/886' MSL.  
 Tree 4241' from DER, 600' left of centerline, 80' AGL/892' MSL.  
 Trees, terrain, fence, buildings, pole, beginning 4573' from DER, 42' left of centerline, up to 88' AGL/929' MSL.  
 Tree 5543' from DER, 176' left of centerline, 77' AGL/939' MSL.  
 Trees, beginning 5549' from DER, 16' left of centerline, up to 84' AGL/947' MSL.  
 Transmission line 1.1 NM from DER, 1896' right of centerline, 125' AGL/969' MSL.  
 Transmission line, trees, beginning 1.1 NM from DER, 12' right of centerline, up to 128' AGL/999' MSL.  
 Transmission line, trees, beginning 1.1 NM from DER, 22' left of centerline, up to 162' AGL/1009' MSL.  
 Tree 1.3 NM from DER, 1626' left of centerline, 115' AGL/944' MSL.

22 FEB 2024 to 21 MAR 2024

22 FEB 2024 to 21 MAR 2024

# TAKEOFF MINIMUMS, (OBSTACLE) DEPARTURE PROCEDURES, AND DIVERSE VECTOR AREA (RADAR VECTORS)

24025

EC-2

# TAKEOFF MINIMUMS, (OBSTACLE) DEPARTURE PROCEDURES, AND DIVERSE VECTOR AREA (RADAR VECTORS)

24025

## JEFFERSONVILLE, IN

CLARK RGNL (JVY)

TAKEOFF MINIMUMS AND (OBSTACLE) DEPARTURE PROCEDURES

AMDT 3 13SEP18 (18256) (FAA)

TAKEOFF MINIMUMS:

**Rwy 14**, 300-1¼ or std. w/min. climb of 230' per NM to 900.**Rwy 32**, std. w/min. climb of 225' per NM to 1600 or 1900-3 for VCOA.

DEPARTURE PROCEDURE:

**Rwy 14**, climb heading 140° to 1300 before turning right.**Rwy 18**, climb heading 182° to 1600 before turning right.**Rwy 32**, climb heading 320° to 2000 before turning left.**Rwy 36**, climb heading 002° to 1600 before turning left.

VCOA:

**Rwy 32**, obtain ATC approval for VCOA when requesting IFR clearance. Climb in visual conditions to cross Clark RGNL Airport at or above 2200 before proceeding on course.

TAKEOFF OBSTACLE NOTES:

**Rwy 14**, sign and tree beginning 22' from DER, 88' right of centerline, up to 7' AGL/465' MSL.

Tree 73' from DER, 266' left of centerline, 529' MSL.

Tree 123' from DER, 377' left of centerline, 540' MSL.

Tree and pole beginning 126' from DER, 29' left of centerline, up to 92' AGL/553' MSL.

Tree 205' from DER, 176' right of centerline, 21' AGL/468' MSL.

Tree 248' from DER, 179' right of centerline, 23' AGL/470' MSL.

Trees beginning 372' from DER, 41' right of centerline, up to 41' AGL/491' MSL.

Trees beginning 397' from DER, 129' right of centerline, up to 51' AGL/503' MSL.

Trees beginning 420' from DER, 22' right of centerline, up to 506' MSL.

Tree 563' from DER, 266' right of centerline, 518' MSL.

Trees beginning 565' from DER, 422' right of centerline, up to 526' MSL.

Trees beginning 596' from DER, 175' right of centerline, up to 100' AGL/536' MSL.

Catenary, tree and pole beginning 1615' from DER, 252' left of centerline, up to 563' MSL.

Tree 1693' from DER, 858' right of centerline, 537' MSL.

Tree 1793' from DER, 790' right of centerline, 550' MSL.

Trees beginning 1884' from DER, 732' right of centerline, up to 551' MSL.

Pole, catenary and tree beginning 2085' from DER, 242' left of centerline, up to 566' MSL.

Catenary and transmission line beginning 2148' from DER, 316' left of centerline, up to 580' MSL.

Tower 2207' from DER, 734' left of centerline, 594' MSL.

Tower, catenary, tree and transmission line beginning 2216' from DER, 201' left of centerline, up to 110' AGL/600' MSL.

Tree and catenary beginning 2388' from DER, 321' right of centerline, up to 558' MSL.

Catenary and tree beginning 2507' from DER, 165' left of centerline, up to 607' MSL.

Catenary and tree beginning 2742' from DER, 1025' right of centerline, up to 572' MSL.

Catenary 3380' from DER, 10' right of centerline, 119' AGL/578' MSL.

Catenary 3763' from DER, 202' right of centerline, 95' AGL/590' MSL.

Catenary 4265' from DER, 508' right of centerline, 593' MSL.

Antenna 1.5 NM from DER, 1335' left of centerline, 171' AGL/730' MSL.

**Rwy 18**, tree 262' from DER, 523' left of centerline, 50' AGL/490' MSL.

Tree 301' from DER, 515' right of centerline, 53' AGL/492' MSL.

Trees beginning 320' from DER, 475' right of centerline, up to 496' MSL.

Tree 369' from DER, 543' left of centerline, 493' MSL.

Tree and building beginning 545' from DER, 94' right of centerline, up to 508' MSL.

Trees beginning 559' from DER, 105' left of centerline, up to 512' MSL.

Trees beginning 1223' from DER, 691' left of centerline, up to 526' MSL.

Trees beginning 1375' from DER, 791' left of centerline, up to 90' AGL/538' MSL.

Tree 1716' from DER, 777' left of centerline, 545' MSL.

Tree and tank beginning 1720' from DER, 29' right of centerline, up to 96' AGL/559' MSL.

Trees beginning 1778' from DER, 746' left of centerline, up to 552' MSL.

Trees beginning 1946' from DER, 676' left of centerline, up to 559' MSL.

Trees beginning 2254' from DER, 164' left of centerline, up to 563' MSL.

Trees beginning 3221' from DER, 678' right of centerline, up to 562' MSL.

Trees beginning 3833' from DER, 303' left of centerline, up to 86' AGL/570' MSL.

Catenary and transmission line beginning 4274' from DER, 564' left of centerline, up to 603' MSL.

Catenary and transmission line beginning 4976' from DER, 254' left of centerline, up to 125' AGL/610' MSL.

Catenary 5675' from DER, 681' right of centerline, 606' MSL.

**Rwy 32**, sign 19' from DER, 87' left of centerline, 8' AGL/474' MSL.

Tree 40' from DER, 419' right of centerline, 87' AGL/542' MSL.

Tree 145' from DER, 447' right of centerline, 101' AGL/557' MSL.

Tree, pole and building beginning 192' from DER, 12' right of centerline, up to 91' AGL/546' MSL.

Tree, pole and traverse way beginning 386' from DER, 8' left of centerline, up to 70' AGL/531' MSL.

Trees beginning 1054' from DER, 9' right of centerline, up to 101' AGL/560' MSL.

Tree 1638' from DER, 744' left of centerline, 534' MSL.

Trees beginning 1648' from DER, 608' left of centerline, up to 541' MSL.

Trees beginning 1819' from DER, 518' left of centerline, up to 542' MSL.

Trees beginning 2052' from DER, 11' left of centerline, up to 101' AGL/569' MSL.

Tree 2824' from DER, 1250' left of centerline, 575' MSL.

Trees beginning 3038' from DER, 1195' left of centerline, up to 576' MSL.

Trees beginning 3296' from DER, 895' right of centerline, up to 567' MSL.

Trees beginning 3501' from DER, 821' right of centerline, up to 582' MSL.

CONT

# TAKEOFF MINIMUMS, (OBSTACLE) DEPARTURE PROCEDURES, AND DIVERSE VECTOR AREA (RADAR VECTORS)

24025

EC-2

# TAKEOFF MINIMUMS, (OBSTACLE) DEPARTURE PROCEDURES, AND DIVERSE VECTOR AREA (RADAR VECTORS)

24025

## JEFFERSONVILLE, IN (CON'T)

### CLARK RGNL (JVY) (CON'T)

**Rwy 32 (CON'T)**, trees beginning 3880' from DER, 563' left of centerline, up to 600' MSL.

Trees beginning 4783' from DER, 1553' left of centerline, up to 616' MSL.

**Rwy 36**, fence 172' from DER, 462' right of centerline, 482' MSL.

Traverse way 330' from DER, 508' right of centerline, 494' MSL.

Tree 418' from DER, 596' left of centerline, 505' MSL.

Trees beginning 604' from DER, 596' left of centerline, up to 527' MSL.

Pole 1130' from DER, 791' right of centerline, 513' MSL.

Pole 1310' from DER, 568' right of centerline, 515' MSL.

Transmission line 1648' from DER, 888' right of centerline, 92' AGL/544' MSL.

Catenary, tree and pole beginning 1648' from DER, 603' right of centerline, up to 548' MSL.

Trees beginning 2148' from DER, 821' left of centerline, up to 94' AGL/552' MSL.

Trees beginning 2216' from DER, 555' left of centerline, up to 553' MSL.

Tree 2823' from DER, 871' right of centerline, 550' MSL.

Tree 3009' from DER, 1296' right of centerline, 552' MSL.

Tree 3055' from DER, 818' right of centerline, 562' MSL.

Transmission line and tree beginning 3192' from DER, 321' right of centerline, up to 71' AGL/564' MSL.

## KENDALLVILLE, IN

### KENDALLVILLE MUNI (C62)

#### TAKEOFF MINIMUMS AND (OBSTACLE) DEPARTURE PROCEDURES

AMDT 2 16JAN86 (86016) (FAA)

#### DEPARTURE PROCEDURE:

**Rwys 10, 28**, climb runway heading to 1500 before turning south.

## KENT, OH

### KENT STATE UNIVERSITY (1G3)

#### TAKEOFF MINIMUMS AND (OBSTACLE) DEPARTURE PROCEDURES

ORIG 31MAY12 (21224) (FAA)

#### TAKEOFF OBSTACLE NOTES:

**Rwy 1**, trees, transmission poles, and a chimney beginning 72' from DER, 369' right of centerline, up to 69' AGL/1179' MSL.

Trees and a transmission pole beginning 394' from DER, 249' left of centerline, up to 97' AGL/1203' MSL.

**Rwy 19**, vehicles on road, poles, and a tree beginning 331' from DER, 325' left of centerline, up to 42' AGL/1144' MSL.

Trees and a building beginning 61' from DER, 412' from centerline, up to 81' AGL/1185' MSL.

Trees beginning 1240' from DER, left and right of centerline, up to 109' AGL/1218' MSL.

## KENTLAND, IN

### KENTLAND MUNI (501)

#### TAKEOFF MINIMUMS AND (OBSTACLE) DEPARTURE PROCEDURES

AMDT 1 14SEP17 (17257)

#### DEPARTURE PROCEDURE:

**Rwy 27**, climb heading 260° to 1100' before proceeding on course.

#### TAKEOFF OBSTACLE NOTES:

**Rwy 9**, vehicle on road 486' from DER, crossing centerline, 715' MSL/15' AGL.

Trees beginning 571' from DER, 116' right of centerline, up to 770' MSL/70' AGL.

**Rwy 27**, trees, building, pole beginning 533' from DER, 146' right of centerline, up to 765' MSL.

Pole beginning 746' from DER, 25' left of centerline, up to 23' AGL/723' MSL.

Pole beginning 925' from DER, 130' left of centerline, up to 27' AGL/724' MSL.

Tree 1215' from DER, 450' left of centerline, 733' MSL.

## KENTON, OH

### HARDIN COUNTY (I95)

#### TAKEOFF MINIMUMS AND (OBSTACLE) DEPARTURE PROCEDURES

AMDT 3 13JAN11 (11013) (FAA)

#### TAKEOFF OBSTACLE NOTES:

**Rwy 4**, trees, buildings, antenna on building, light poles, and flag poles beginning 31' from DER, 240' left of centerline, up to 29' AGL/1027' MSL.

Sign 103' from DER, 204' right of centerline, 8' AGL/1012' MSL.

Trees beginning 877' from DER, left and right of centerline, up to 103' AGL/1093' MSL.

**Rwy 22**, trees and buildings beginning 7' from DER, 484' left of centerline, up to 77' AGL/1103' MSL.

Trees beginning 179' from DER, 51' right of centerline, up to 108' AGL/1122' MSL.

Trees beginning 1345' from DER, left and right of centerline, up to 115' AGL/1158' MSL.

# TAKEOFF MINIMUMS, (OBSTACLE) DEPARTURE PROCEDURES, AND DIVERSE VECTOR AREA (RADAR VECTORS)

24025

EC-2

# TAKEOFF MINIMUMS, (OBSTACLE) DEPARTURE PROCEDURES, AND DIVERSE VECTOR AREA (RADAR VECTORS)

24025

## KNOX, IN

### STARKE COUNTY (OXI)

#### TAKEOFF MINIMUMS AND (OBSTACLE) DEPARTURE PROCEDURES

ORIG 25SEP08 (08269) (FAA)

#### TAKEOFF MINIMUMS:

**Rwys 9, 27**, NA-Environmental.

#### TAKEOFF OBSTACLE NOTES:

**Rwy 36**, tree 1234' from DER, 477' left of centerline, 35' AGL/715' MSL.

**Rwy 18**, trees beginning 2442' from DER, 135' right of centerline, up to 86' AGL/769' MSL.

Tree 21' from DER, 449' left of centerline, 5' AGL/668' MSL.

## KOKOMO, IN

### KOKOMO MUNI (OKK)

#### TAKEOFF MINIMUMS AND (OBSTACLE) DEPARTURE PROCEDURES

AMDT 1 23JUN16 (16175) (FAA)

#### TAKEOFF OBSTACLE NOTES:

**Rwy 5**, sign 20' from DER, 210' left of centerline, 3' AGL/821' MSL.

Trees beginning 501' from DER, 361' right of centerline, up to 57' AGL/870' MSL.

Tree 640' from DER, 466' left of centerline, 20' AGL/835' MSL.

Pole 642' from DER, 653' left of centerline, 843' MSL.

Buildings beginning 908' from DER, 706' left of centerline, up to 37' AGL/856' MSL.

Pole 971' from DER, 610' left of centerline, up to 39' AGL/858' MSL.

Trees, poles beginning 1042' from DER, 609' left of centerline, up to 48' AGL/870' MSL.

Elevator 1835' from DER, 361' right of centerline, 41' AGL/867' MSL.

Trees beginning 3730' from DER, 1373' left of centerline, up to 928' MSL.

Trees beginning 3747' from DER, 1245' left of centerline, up to 936' MSL.

**Rwy 14**, tree, bush beginning 6' from DER, 196' left of centerline, up to 31' AGL/849' MSL.

Tree, fence, vertical structure beginning 53' from DER, 153' right of centerline, up to 9' AGL/831' MSL.

Bush, fence beginning 116' from DER, 297' right of centerline, up to 842' MSL.

Building 2117' from DER, 488' left of centerline, 58' AGL/880' MSL.

Building, elevator beginning 2120' from DER, 485' left of centerline, up to 885' MSL.

Tree 2181' from DER, 215' left of centerline, 64' AGL/890' MSL.

Trees beginning 2186' from DER, 213' left of centerline, up to 77' AGL/904' MSL.

Tree 2945' from DER, 1073' right of centerline, 899' MSL.

**Rwy 32**, post 0' from DER, 149' right of centerline, 4' AGL/828' MSL.

Buildings beginning 133' from DER, 493' right of centerline, up to 15' AGL/837' MSL.

Buildings beginning 155' from DER, 490' right of centerline, up to 20' AGL/843' MSL.

Poles beginning 706' from DER, 520' right of centerline, up to 49' AGL/873' MSL.

Buildings, elevator, trees beginning 1592' from DER, 414' left of centerline, up to 68' AGL/889' MSL.

Tree 4804' from DER, 500' left of centerline, 121' AGL/949' MSL.

## LA PORTE, IN

### LA PORTE MUNI (PPO)

#### TAKEOFF MINIMUMS AND (OBSTACLE) DEPARTURE PROCEDURES

AMDT 2 05JUL07 (07186) (FAA)

#### TAKEOFF OBSTACLE NOTES:

**Rwy 14**, power line beginning 4937' from DER, 670' right of centerline, 150' AGL/934' MSL.

**Rwy 20**, power line beginning 3978' from DER, 1566' left of centerline, 150' AGL/959' MSL.

## LAFAYETTE, IN

### PURDUE UNIVERSITY (LAF)

#### TAKEOFF MINIMUMS AND (OBSTACLE) DEPARTURE PROCEDURES

AMDT 1A 30NOV23 (23334) (FAA)

#### TAKEOFF MINIMUMS:

**Rwy 5**, 300-1/4 or std w/min climb of 342'/NM to 1000.

**Rwy 23**, 400-2/4 or std w/min climb of 225'/NM to 1100.

#### TAKEOFF OBSTACLE NOTES:

**Rwy 5**, building, terrain, trees, vehicles on road beginning 11' from DER, 75' left of centerline, up to 31' AGL/642' MSL.

Fence 42' from DER, 423' right of centerline, 609' MSL.

Fence 124' from DER, 329' right of centerline, 610' MSL.

Poles, vehicles on road, terrain beginning 186' from DER, 135' left of centerline, up to 34' AGL/645' MSL.

Fence 189' from DER, 249' right of centerline, 612' MSL.

Fence 259' from DER, 164' right of centerline, 6' AGL/613' MSL.

Fence 269' from DER, 155' right of centerline, 12' AGL/619' MSL.

Poles, fences, vehicles on road beginning 289' from DER, 2' right of centerline, up to 20' AGL/621' MSL.

Pole, vehicles on road beginning 408' from DER, 227' left of centerline, up to 38' AGL/646' MSL.

Poles, vehicles on road beginning 416' from DER, 16' right of centerline, up to 20' AGL/623' MSL.

Transmission line, vehicles on road, pole beginning 459' from DER, 25' left of centerline, up to 39' AGL/648' MSL.

Trees, pole, vehicles on road beginning 685' from DER, 36' left of centerline, up to 649' MSL.

Vehicles on road 736' from DER, 65' right of centerline, 626' MSL.

Transmission line 867' from DER, 434' left of centerline, 39' AGL/650' MSL.

CON'T

# TAKEOFF MINIMUMS, (OBSTACLE) DEPARTURE PROCEDURES, AND DIVERSE VECTOR AREA (RADAR VECTORS)

24025

EC-2

# TAKEOFF MINIMUMS, (OBSTACLE) DEPARTURE PROCEDURES, AND DIVERSE VECTOR AREA (RADAR VECTORS)

24025

## LAFAYETTE, IN (CON'T)

### PURDUE UNIVERSITY (LAF) (CON'T)

**Rwy 5 (CON'T)**, trees, poles beginning 901' from DER, 424' left of centerline, up to 651' MSL.  
 Tree 995' from DER, 212' right of centerline, 36' AGL/638' MSL.  
 Tree 1000' from DER, 33' right of centerline, 40' AGL/649' MSL.  
 Tree 1042' from DER, 642' left of centerline, 654' MSL.  
 Tree, transmission line beginning 1046' from DER, 312' left of centerline, up to 49' AGL/660' MSL.  
 Tree 1125' from DER, 245' left of centerline, 50' AGL/661' MSL.  
 Trees, transmission lines, poles beginning 1146' from DER, 49' left of centerline, up to 684' MSL.  
 Poles beginning 1568' from DER, 49' right of centerline, up to 48' AGL/657' MSL.  
 Tree 1887' from DER, 256' right of centerline, 66' AGL/663' MSL.  
 Tree 2065' from DER, 239' right of centerline, 63' AGL/667' MSL.  
 Tree 2109' from DER, 203' right of centerline, 61' AGL/668' MSL.  
 Trees, buildings beginning 2116' from DER, 275' left of centerline, up to 694' MSL.  
 Building 3150' from DER, 34' right of centerline, 67' AGL/687' MSL.  
 Poles beginning 3257' from DER, 241' right of centerline, up to 76' AGL/696' MSL.  
 Tree 3507' from DER, 1179' left of centerline, 697' MSL.  
 Building 3594' from DER, 278' right of centerline, 102' AGL/723' MSL.  
 Building 4187' from DER, 1567' left of centerline, 92' AGL/717' MSL.  
 Buildings, building spire beginning 4731' from DER, 385' left of centerline, up to 747' MSL.  
 Buildings beginning 4908' from DER, 771' left of centerline, up to 143' AGL/767' MSL.  
 Building 4954' from DER, 1036' right of centerline, 752' MSL.  
 Building 5069' from DER, 870' right of centerline, 167' AGL/780' MSL.  
 Building 5541' from DER, 784' left of centerline, 162' AGL/782' MSL.  
 Building 5579' from DER, 778' left of centerline, 784' MSL.  
 Smokestack 5718' from DER, 633' left of centerline, 850' MSL.  
**Rwy 10**, trees beginning 696' from DER, 629' right of centerline, up to 95' AGL/642' MSL.  
 Tree 857' from DER, 697' left of centerline, 61' AGL/643' MSL.  
**Rwy 23**, fences beginning 50' from DER, 498' right of centerline, up to 605' MSL.  
 Tree 89' from DER, 235' left of centerline, 24' AGL/613' MSL.  
 Tree 171' from DER, 278' left of centerline, 31' AGL/617' MSL.  
 Tree 324' from DER, 281' left of centerline, 43' AGL/622' MSL.  
 Tower and antenna 1.9 NM from DER, 269' left of centerline, up to 321' AGL/923' MSL.  
**Rwy 28**, tree 1190' from DER, 470' left of centerline, 630' MSL.  
 Trees beginning 1752' from DER, 765' right of centerline, up to 669' MSL.  
 Tree 2166' from DER, 675' left of centerline, 96' AGL/656' MSL.  
 Tree 2744' from DER, 1020' right of centerline, 672' MSL.  
 Trees beginning 2751' from DER, 954' right of centerline, up to 689' MSL.  
 Trees beginning 2968' from DER, 984' right of centerline, up to 697' MSL.  
 Trees beginning 3132' from DER, 920' right of centerline, up to 722' MSL.

## LANCASTER, OH

### FAIRFIELD COUNTY (LHQ)

#### TAKEOFF MINIMUMS AND (OBSTACLE) DEPARTURE PROCEDURES

AMDT 2 12DEC13 (13346) (FAA)

##### TAKEOFF MINIMUMS:

**Rwy 10**, 400-2 or std. w/min. climb of 310' per NM to 1400.

##### DEPARTURE PROCEDURE:

**Rwy 10**, climb heading 100° to 1600 before proceeding on course.

##### TAKEOFF OBSTACLE NOTES:

**Rwy 10**, trees beginning 1571' from DER, 647' right of centerline, up to 56' AGL/927' MSL.  
 Trees beginning 1617' from DER, 509' left of centerline, up to 89' AGL/974' MSL.  
 Trees beginning 2131' from DER, 460' right of centerline, up to 74' AGL/945' MSL.  
 Trees beginning 5480' from DER, 173' right of centerline, up to 76' AGL/1037' MSL.  
 Trees beginning 1.1 NM from DER, 724' left of centerline, up to 84' AGL/1061' MSL.  
 Tree 1.9 NM from DER, 1990' right of centerline, 100' AGL/1259' MSL.  
**Rwy 28**, trees beginning 738' from DER, 315' left of centerline, up to 77' AGL/912' MSL.  
 Trees 1509' from DER, 97' right of centerline, up to 76' AGL/897' MSL.  
 Trees beginning 1906' from DER, 358' right of centerline, up to 107' AGL/942' MSL.  
 Silo 2230' from DER, 267' left of centerline, 60' AGL/915' MSL.

22 FEB 2024 to 21 MAR 2024

22 FEB 2024 to 21 MAR 2024

# TAKEOFF MINIMUMS, (OBSTACLE) DEPARTURE PROCEDURES, AND DIVERSE VECTOR AREA (RADAR VECTORS)

24025

# TAKEOFF MINIMUMS, (OBSTACLE) DEPARTURE PROCEDURES, AND DIVERSE VECTOR AREA (RADAR VECTORS)

24025

## LEBANON, OH

WARREN COUNTY/JOHN LANE FLD (I68)

TAKEOFF MINIMUMS AND (OBSTACLE) DEPARTURE PROCEDURES

AMDT 1 20SEP12 (22083) (FAA)

TAKEOFF OBSTACLE NOTES:

**Rwy 1**, terrain and tree beginning 36' from DER, 320' left of centerline, up to 50' AGL/958' MSL.

Trees beginning 1084' from DER, left and right of centerline, up to 65' AGL/955' MSL.

Trees beginning 1510' from DER, left and right of centerline, up to 80' AGL/986' MSL.

Trees beginning 2001' from DER, 83' left of centerline, up to 100' AGL/1015' MSL.

**Rwy 19**, vehicles on roadway beginning abeam the DER, left and right of centerline, up to 15' AGL/901' MSL.

Terrain beginning 32' from DER, left and right of centerline, up to 886' MSL.

Buildings 74' from DER, 425' right of centerline, up to 15' AGL/892' MSL.

Trees 252' from DER, 359' right of centerline, up to 60' AGL/948' MSL.

Trees beginning 1089' from DER, 179' left of centerline, up to 55' AGL/952' MSL.

Trees beginning 1804' from DER, left and right of centerline, up to 85' AGL/960' MSL.

## LIMA, OH

LIMA ALLEN COUNTY (AOH)

TAKEOFF MINIMUMS AND (OBSTACLE) DEPARTURE PROCEDURES

AMDT 1A 16AUG18 (18228) (FAA)

TAKEOFF OBSTACLE NOTES:

**Rwy 10**, bush beginning 162' from DER, 310' right of centerline, up to 4' AGL/983' MSL.

**Rwy 28**, multiple trees beginning 1343' from DER, 160' right of centerline, up to 71' AGL/1015' MSL.

## LOGANSPORT, IN

LOGANSPORT/CASS COUNTY (GGP)

TAKEOFF MINIMUMS AND (OBSTACLE) DEPARTURE PROCEDURES

AMDT 2 12AUG21 (21224) (FAA)

TAKEOFF OBSTACLE NOTES:

**Rwy 9**, fence 9' from DER, 443' right of centerline, 11' AGL/744' MSL.

Fence 187' from DER, 497' left of centerline, 11' AGL/743' MSL.

Tree 934' from DER, 730' left of centerline, 791' MSL.

Tree 2218' from DER, 487' right of centerline, 62' AGL/794' MSL.

**Rwy 27**, terrain 4' from DER, 495' left of centerline, 739' MSL.

Lighting 8' from DER, 17' right of centerline, 2' AGL/738' MSL.

Poles beginning 638' from DER, 489' right of centerline, up to 34' AGL/763' MSL.

Pole 734' from DER, 331' right of centerline, 39' AGL/767' MSL.

Poles beginning 924' from DER, 334' left of centerline, up to 39' AGL/773' MSL.

Tree 2041' from DER, 143' left of centerline, 65' AGL/801' MSL.

Tree 3360' from DER, 1358' left of centerline, 825' MSL.

Trees beginning 3374' from DER, 1002' left of centerline, up to 842' MSL.

## LONDON, OH

MADISON COUNTY (UYF)

TAKEOFF MINIMUMS AND (OBSTACLE) DEPARTURE PROCEDURES

AMDT 1 30JAN20 (20030) (FAA)

TAKEOFF OBSTACLE NOTES:

**Rwy 9**, tree 164' from DER, 484' left of centerline, 1059' MSL.

Trees beginning 289' from DER, 417' left of centerline, up to 1065' MSL.

Pole 1154' from DER, 791' left of centerline, 1080' MSL.

Trees beginning 1330' from DER, 301' left of centerline, up to 1096' MSL.

Tree 1495' from DER, 416' left of centerline, 1103' MSL.

Tree 2591' from DER, 511' left of centerline, 1121' MSL.

**Rwy 27**, vertical structure 53' from DER, 206' left of centerline, 1089' MSL.

Vertical structure 134' from DER, 188' right of centerline, 1085' MSL.

Tree 2091' from DER, 973' right of centerline, 1142' MSL.

22 FEB 2024 to 21 MAR 2024

22 FEB 2024 to 21 MAR 2024

# TAKEOFF MINIMUMS, (OBSTACLE) DEPARTURE PROCEDURES, AND DIVERSE VECTOR AREA (RADAR VECTORS)

24025

EC-2

**TAKEOFF MINIMUMS, (OBSTACLE) DEPARTURE PROCEDURES, AND**

  
**DIVERSE VECTOR AREA (RADAR VECTORS)**

24025

**LORAIN/ELYRIA, OH**

LORAIN COUNTY RGNL (LPR)

TAKEOFF MINIMUMS AND (OBSTACLE) DEPARTURE PROCEDURES

ORIG-A 24MAY18 (18144) (FAA)

TAKEOFF OBSTACLE NOTES:

**Rwy 7**, terrain beginning 21' from DER, 83' left of centerline, up to 801' MSL.

Terrain 180' from DER, 288' right of centerline, 794' MSL.

Terrain beginning 229' from DER, 261' left of centerline, up to 804' MSL.

Terrain 308' from DER, 13' right of centerline, 801' MSL.

Trees beginning 839' from DER, 520' left of centerline, up to 832' MSL.

Tree 972' from DER, 294' right of centerline, 823' MSL.

Trees beginning 1181' from DER, 52' left of centerline, up to 836' MSL.

Tree 1294' from DER, 538' right of centerline, 847' MSL.

Tree 1852' from DER, 431' right of centerline, 861' MSL.

Tree 1875' from DER, 653' right of centerline, 865' MSL.

**Rwy 25**, vegetation 582' from DER, 468' right of centerline, 809' MSL.

Tree 1587' from DER, 697' left of centerline, 838' MSL.

Tree 2180' from DER, 785' right of centerline, 848' MSL.

Tree 2276' from DER, 435' right of centerline, 854' MSL.

**MADISON, IN**

MADISON MUNI (IMS)

TAKEOFF MINIMUMS AND (OBSTACLE) DEPARTURE PROCEDURES

AMDT 2 31JUL08 (08213) (FAA)

TAKEOFF OBSTACLE NOTES:

**Rwy 3**, vehicle on road 625' from DER, on centerline, 15' AGL/844' MSL.

Antenna on building and trees beginning 170' from DER, 432' left of centerline, up to 85' AGL/904' MSL.

Poles and trees beginning 526' from DER, 64' right of centerline, up to 130' AGL/959' MSL.

**Rwy 21**, vehicle on road 575' from DER, on centerline, 15' AGL/824' MSL.

Trees and poles beginning 285' from DER, 16' left of centerline, up to 157' AGL/947' MSL.

Trees and pole beginning 116' from DER, 1' right of centerline, up to 123' AGL/912' MSL.

**MANSFIELD, OH**

MANSFIELD LAHM RGNL (MFD)

TAKEOFF MINIMUMS AND (OBSTACLE) DEPARTURE PROCEDURES

ORIG 12MAR09 (09071) (FAA)

TAKEOFF OBSTACLE NOTES:

**Rwy 5**, trees 1337' from DER, 209' right of centerline, 78' AGL/1318' MSL.

Trees 1494' from DER, 410' left of centerline, 80' AGL/1330' MSL.

**Rwy 32**, trees 2399' from DER, 868' right of centerline, 90' AGL/1310' MSL.

22 FEB 2024 to 21 MAR 2024

22 FEB 2024 to 21 MAR 2024

**TAKEOFF MINIMUMS, (OBSTACLE) DEPARTURE PROCEDURES, AND**

  
**DIVERSE VECTOR AREA (RADAR VECTORS)**

24025



**TAKEOFF MINIMUMS, (OBSTACLE) DEPARTURE PROCEDURES, AND  
DIVERSE VECTOR AREA (RADAR VECTORS)**

24025

**MARION, IN****MARION MUNI - MCKINNEY FLD (MZZ)****TAKEOFF MINIMUMS AND (OBSTACLE) DEPARTURE PROCEDURES**

AMDT 1 20JUN19 (21224) (FAA)

**TAKEOFF OBSTACLE NOTES:****Rwy 4**, terrain, NAVAID, pole beginning abeam DER, 124' left of centerline, up to 854' MSL.

Pole, NAVAID beginning 34' from DER, 124' right of centerline, up to 852' MSL.

Terrain beginning 68' from DER, 412' right of centerline, up to 856' MSL.

Tree 534' from DER, 612' left of centerline, 890' MSL.

Trees beginning 775' from DER, 435' left of centerline, up to 895' MSL.

Trees beginning 929' from DER, 694' right of centerline, up to 65' AGL/914' MSL.

Trees beginning 1082' from DER, 13' left of centerline, up to 915' MSL.

Trees beginning 1283' from DER, 8' right of centerline, up to 921' MSL.

Trees beginning 1672' from DER, 107' left of centerline, up to 927' MSL.

Trees beginning 1852' from DER, 30' left of centerline, up to 936' MSL.

Trees beginning 2280' from DER, 42' right of centerline, up to 927' MSL.

Trees beginning 2749' from DER, 838' left of centerline, up to 942' MSL.

Tree 3145' from DER, 1200' right of centerline, 937' MSL.

**Rwy 15**, trees beginning 77' from DER, 224' left of centerline, up to 921' MSL.

Terrain 116' from DER, 462' right of centerline, 855' MSL.

Vegetation, terrain beginning 162' from DER, 282' right of centerline, up to 858' MSL.

Trees beginning 431' from DER, 239' left of centerline, up to 925' MSL.

Tree 539' from DER, 269' right of centerline, 51' AGL/901' MSL.

Tree, pole, vehicle on traverse way beginning 569' from DER, 63' left of centerline, up to 926' MSL.

Tree 676' from DER, 393' right of centerline, 904' MSL.

Tree 701' from DER, 331' right of centerline, 73' AGL/914' MSL.

Trees beginning 780' from DER, 361' right of centerline, up to 95' AGL/941' MSL.

Trees beginning 870' from DER, 361' right of centerline, up to 102' AGL/943' MSL.

Tree, pole beginning 1102' from DER, 20' right of centerline, up to 107' AGL/948' MSL.

Trees beginning 2580' from DER, 70' left of centerline, up to 942' MSL.

**Rwy 22**, pole 902' from DER, 572' left of centerline, 24' AGL/881' MSL.

Tree 1651' from DER, 605' right of centerline, 45' AGL/904' MSL.

Tree, pole beginning 1717' from DER, 760' right of centerline, up to 921' MSL.

**Rwy 33**, sign 11' from DER, 72' right of centerline, 3' AGL/859' MSL.

Vegetation 61' from DER, 242' left of centerline, 11' AGL/864' MSL.

Pole, vehicle on traverse way, tree, transmission line beginning 366' from DER, 261' left of centerline, up to 38' AGL/895' MSL.

Tree 725' from DER, 427' left of centerline, 908' MSL.

Trees beginning 795' from DER, 507' right of centerline, up to 928' MSL.

Tree, pole beginning 815' from DER, 362' left of centerline, up to 58' AGL/913' MSL.

Tree, pole beginning 889' from DER, 4' right of centerline, up to 931' MSL.

Tree 986' from DER, 741' left of centerline, 88' AGL/941' MSL.

Trees beginning 1006' from DER, 130' left of centerline, up to 94' AGL/946' MSL.

Tree 2839' from DER, 1245' left of centerline, 948' MSL.

Tree 2989' from DER, 1133' left of centerline, 950' MSL.

Trees beginning 3140' from DER, 1063' left of centerline, up to 959' MSL.

Trees beginning 3257' from DER, 1' left of centerline, up to 111' AGL/965' MSL.

Tree 3426' from DER, 106' right of centerline, 947' MSL.

Tree 3579' from DER, 144' right of centerline, 952' MSL.

Trees beginning 3695' from DER, 29' right of centerline, up to 958' MSL.

**MARION, OH****MARION MUNI (MNN)****TAKEOFF MINIMUMS AND (OBSTACLE) DEPARTURE PROCEDURES**

ORIG 30AUG07 (07242) (FAA)

**DEPARTURE PROCEDURE:****Rwy 25**, climb heading 245° to 1600 before turning right.**TAKEOFF OBSTACLE NOTES:****Rwy 7**, trees 3283' from DER, 273' left of centerline, up to 89' AGL/1088' MSL.

Multiple trees beginning 36' from DER, 280' right of centerline, up to 43' AGL/1033' MSL.

**Rwy 13**, trees 512' from DER, 277' left of centerline, up to 100' AGL/1089' MSL.

Road 491' from DER, 15' AGL/1004' MSL.

**Rwy 25**, obstruction light on antenna 419' from DER, 407' left of centerline, up to 13' AGL/1008' MSL.

Road 434' from DER, 15' AGL/1004' MSL.

**Rwy 31**, trees 2186' from DER, up to 100' AGL/1089' MSL.

Road 355' from DER, 485' left of centerline, 15' AGL/1004' MSL.

22 FEB 2024 to 21 MAR 2024

22 FEB 2024 to 21 MAR 2024

**TAKEOFF MINIMUMS, (OBSTACLE) DEPARTURE PROCEDURES, AND  
DIVERSE VECTOR AREA (RADAR VECTORS)**

24025

# TAKEOFF MINIMUMS, (OBSTACLE) DEPARTURE PROCEDURES, AND DIVERSE VECTOR AREA (RADAR VECTORS)

24025

## MARYSVILLE, OH

### UNION COUNTY (MRT)

#### TAKEOFF MINIMUMS AND (OBSTACLE) DEPARTURE PROCEDURES

AMDT 3 30NOV23 (23334) (FAA)

##### TAKEOFF MINIMUMS:

**Rwys 8, 26**, NA-Environmental.

##### TAKEOFF OBSTACLE NOTES:

**Rwy 9**, sign 12' from DER, 51' left of centerline, 4' AGL/999' MSL.

Trees, light pole beginning 16' from DER, 78' left of centerline, up to 1000' MSL.

Pole 290' from DER, 499' left of centerline, 40' AGL/1032' MSL.

Pole, traverse ways beginning 364' from DER, 169' left of centerline, up to 41' AGL/1033' MSL.

Trees, traverse ways beginning 479' from DER, 27' left of centerline, up to 69' AGL/1063' MSL.

Traverse ways beginning 591' from DER, 5' right of centerline, up to 1018' MSL.

Bldg, trees beginning 721' from DER, 199' left of centerline, up to 1080' MSL.

Poles beginning 1034' from DER, 398' right of centerline, up to 52' AGL/1038' MSL.

Trees beginning 1572' from DER, 158' left of centerline, up to 1081' MSL.

Trees beginning 1720' from DER, 131' left of centerline, up to 1084' MSL.

Trees beginning 1909' from DER, 175' left of centerline, up to 1088' MSL.

Trees beginning 1946' from DER, 145' left of centerline, up to 1090' MSL.

**Rwy 27**, sign 10' from DER, 52' right of centerline, 4' AGL/1022' MSL.

Tree 42' from DER, 471' right of centerline, 1027' MSL.

Buildings, tree, pole beginning 56' from DER, 396' right of centerline, up to 30' AGL/1037' MSL.

Pole 218' from DER, 337' left of centerline, 33' AGL/1034' MSL.

Trees beginning 458' from DER, 526' right of centerline, up to 63' AGL/1066' MSL.

Trees 1893' from DER, 808' right of centerline, 1069' MSL.

Antenna 2753' from DER, 463' right of centerline, 1094' MSL.

## MEDINA, OH

### MEDINA MUNI (1G5)

#### TAKEOFF MINIMUMS AND (OBSTACLE) DEPARTURE PROCEDURES

AMDT 4 18NOV10 (10322) (FAA)

##### TAKEOFF OBSTACLE NOTES:

**Rwy 1**, vehicle on road 534' from DER, on centerline 15' AGL/1214' MSL.

Trees beginning 562' from DER, 588' left of centerline, up to 100' AGL/1279' MSL.

Trees beginning 1925' from DER on centerline, up to 100' AGL/1319' MSL.

**Rwy 9**, trees beginning 305' from DER, 396' right of centerline, up to 100' AGL/1249' MSL.

Tower 3626' from DER, 533' left of centerline, 189' AGL/1321' MSL.

**Rwy 19**, trees beginning at DER, 112' left of centerline, up to 100' AGL/1289' MSL.

Trees beginning 1490' from DER, 150' right of centerline, up to 100' AGL/1289' MSL.

**Rwy 27**, trees beginning at DER, 345' left of centerline, up to 100' AGL/1319' MSL.

Trees beginning at DER, 366' right of centerline, up to 100' AGL/1279' MSL.

Vehicle on road 501' from DER, on centerline, 15' AGL/1184' MSL.

## MICHIGAN CITY, IN

### MICHIGAN CITY MUNI-PHILLIPS FLD (MGC)

#### TAKEOFF MINIMUMS AND (OBSTACLE) DEPARTURE PROCEDURES

AMDT 2A 07SEP23 (23250) (FAA)

##### DEPARTURE PROCEDURE:

**Rwy 20**, climb on heading 203° to 1200 before turning left.

##### TAKEOFF OBSTACLE NOTES:

**Rwy 2**, pole 12' from DER, 427' left of centerline, 28' AGL/659' MSL.

Tree 12' from DER, 493' left of centerline, 674' MSL.

Terrain 13' from DER, 172' right of centerline, 643' MSL.

Tree 51' from DER, 349' left of centerline, 685' MSL.

Tree 65' from DER, 443' left of centerline, 691' MSL.

Terrain 129' from DER, 497' right of centerline, 649' MSL.

Trees beginning 198' from DER, 337' left of centerline, up to 710' MSL.

Traverse way 303' from DER, 568' right of centerline, 667' MSL.

Pole, tree beginning 344' from DER, 213' right of centerline, up to 37' AGL/687' MSL.

Trees beginning 468' from DER, 231' left of centerline, up to 712' MSL.

Tree 615' from DER, 380' right of centerline, 711' MSL.

Trees, antenna beginning 641' from DER, 46' right of centerline, up to 731' MSL.

Trees beginning 949' from DER, 67' left of centerline, up to 716' MSL.

Trees beginning 1091' from DER, 347' left of centerline, up to 723' MSL.

Trees, antenna beginning 1250' from DER, 2' right of centerline, up to 733' MSL.

Trees beginning 1553' from DER, 89' left of centerline, up to 726' MSL.

Trees beginning 1657' from DER, 6' left of centerline, up to 731' MSL.

Trees beginning 1709' from DER, on centerline, up to 734' MSL.

Antenna, trees beginning 1778' from DER, on centerline, up to 101' AGL/742' MSL.

Tree 1796' from DER, 655' right of centerline, 745' MSL.

Trees beginning 1815' from DER, 134' right of centerline, up to 748' MSL.

Trees beginning 2006' from DER, 166' right of centerline, up to 753' MSL.

Trees beginning 2025' from DER, 94' right of centerline, up to 754' MSL.

CONT

# TAKEOFF MINIMUMS, (OBSTACLE) DEPARTURE PROCEDURES, AND DIVERSE VECTOR AREA (RADAR VECTORS)

24025

# TAKEOFF MINIMUMS, (OBSTACLE) DEPARTURE PROCEDURES, AND DIVERSE VECTOR AREA (RADAR VECTORS)

24025

## MICHIGAN CITY, IN (CON'T)

### MICHIGAN CITY MUNI-PHILLIPS FLD (MGC) (CON'T)

**Rwy 2 (CON'T)**, trees beginning 2123' from DER, 301' right of centerline, up to 758' MSL.

Tree 2160' from DER, 199' left of centerline, 743' MSL.

Trees beginning 2181' from DER, 108' left of centerline, up to 744' MSL.

Trees beginning 2244' from DER, 87' left of centerline, up to 746' MSL.

Trees beginning 2251' from DER, 93' right of centerline, up to 760' MSL.

Trees, electrical system, transmission line beginning 2300' from DER, 11' right of centerline, up to 765' MSL.

Trees beginning 2527' from DER, 22' left of centerline, up to 751' MSL.

Transmission line, trees beginning 3193' from DER, 182' left of centerline, up to 136' AGL/778' MSL.

Transmission line 4247' from DER, 989' right of centerline, 121' AGL/769' MSL.

**Rwy 20**, trees, fences, sign, traverse ways, pole beginning 7' from DER, 27' right of centerline, up to 727' MSL.

Terrain 20' from DER, 393' left of centerline, 658' MSL.

Terrain 191' from DER, 489' left of centerline, 663' MSL.

Fences beginning 206' from DER, 140' left of centerline, up to 12' AGL/671' MSL.

Pole, fence, traverse ways beginning 213' from DER, 45' left of centerline, up to 25' AGL/687' MSL.

Tree, sign beginning 328' from DER, 39' left of centerline, up to 707' MSL.

Tree 1564' from DER, 582' right of centerline, 729' MSL.

Trees beginning 1641' from DER, 199' right of centerline, up to 749' MSL.

Trees beginning 1699' from DER, 8' left of centerline, up to 741' MSL.

Trees beginning 1732' from DER, 341' right of centerline, up to 762' MSL.

Trees beginning 1752' from DER, 23' right of centerline, up to 763' MSL.

Trees beginning 1847' from DER, 109' left of centerline, up to 764' MSL.

Trees beginning 2054' from DER, 11' right of centerline, up to 764' MSL.

Trees beginning 2085' from DER, 43' left of centerline, up to 766' MSL.

Trees beginning 2286' from DER, 59' left of centerline, up to 769' MSL.

Trees beginning 2359' from DER, 27' left of centerline, up to 770' MSL.

Trees beginning 2473' from DER, 1' right of centerline, up to 768' MSL.

## MIDDLEFIELD, OH

### GAUGA COUNTY (7G8)

#### TAKEOFF MINIMUMS AND (OBSTACLE) DEPARTURE PROCEDURES

AMDT 3 08JUN06 (06159) (FAA)

##### TAKEOFF OBSTACLE NOTES:

**Rwy 11**, railroad 331' from DER, 315' left of centerline, 23' AGL/1182' MSL.

Trees 3144' from DER, 671' left of centerline, 100' AGL/1249' MSL.

**Rwy 29**, railroad 349' from DER, 521' left of centerline, 23' AGL/1212' MSL.

Multiple buildings 993' from DER, 294' right of centerline, 40' AGL/1239' MSL.

Trees 1875' from DER, 791' right of centerline, 100' AGL/1319' MSL.

Tank 2251' from DER, 578' right of centerline, 125' AGL/1315' MSL.

## MIDDLETOWN, OH

### MIDDLETOWN RGNL/HOOK FLD (MWO)

#### TAKEOFF MINIMUMS AND (OBSTACLE) DEPARTURE PROCEDURES

AMDT 2 20SEP12 (21140) (FAA)

##### TAKEOFF MINIMUMS:

**Rwys 8, 26**, NA-Environmental.

**Rwy 23**, 300-1¼ or std. w/min. climb of 880' per NM to 1000.

##### DEPARTURE PROCEDURE:

**Rwy 5**, climb heading 053° to 1500' before proceeding on course.

**Rwy 23**, climb heading 233° to 1300' before proceeding on course.

##### TAKEOFF OBSTACLE NOTES:

**Rwy 5**, vehicles on roadway 17' from DER, left and right of centerline, up to 15' AGL/669' MSL.

Terrain 106' from DER, 447' left of centerline, 661' MSL.

Terrain 335' from DER, 395' left of centerline, 659' MSL.

Trees beginning 676' from DER, left and right of centerline, up to 126' AGL/766' MSL.

Poles beginning 1003' from DER, 259' right of centerline, up to 55' AGL/695' MSL.

**Rwy 23**, trees 1119' from DER, 76' right of centerline, 109' AGL/739' MSL.

Tower 1794' from DER, 603' left of centerline, 63' AGL/703' MSL.

Stack 1997' from DER, 961' left of centerline, 205' AGL/855' MSL.

Tree 1930' from DER, 903' left of centerline, 109' AGL/749' MSL.

## MILLERSBURG, OH

### HOLMES COUNTY (10G)

#### TAKEOFF MINIMUMS AND (OBSTACLE) DEPARTURE PROCEDURES

AMDT 2 20AUG15 (15232) (FAA)

##### TAKEOFF MINIMUMS:

**Rwy 9, 27**, 300-1.

##### TAKEOFF OBSTACLE NOTES:

**Rwy 9**, bushes 136' from DER, 235' left of centerline, up to 25' AGL/1200' MSL.

**Rwy 27**, trees beginning 212' from DER, 443' right of center line, up to 100' AGL/1287' MSL.

Trees and poles beginning 1220' from DER, 158' right of centerline, up to 100' AGL/1315' MSL.

Trees and buildings beginning 1116' from DER, 272' left of centerline, up to 100' AGL/1337' MSL.

# TAKEOFF MINIMUMS, (OBSTACLE) DEPARTURE PROCEDURES, AND DIVERSE VECTOR AREA (RADAR VECTORS)

24025

EC-2

# TAKEOFF MINIMUMS, (OBSTACLE) DEPARTURE PROCEDURES, AND DIVERSE VECTOR AREA (RADAR VECTORS)

24025

## MONTICELLO, IN

WHITE COUNTY (MCX)

TAKEOFF MINIMUMS AND (OBSTACLE) DEPARTURE PROCEDURES

AMDT 3 10NOV16 (16315) (FAA)

TAKEOFF MINIMUMS:

**Rwy 36**, 600-3 or std. w/min. climb of 265' per NM to 1400.

TAKEOFF OBSTACLE NOTES:

**Rwy 18**, trees beginning 23' from DER, 309' left of centerline, up to 739' MSL.

Trees beginning 35' from DER, 296' right of centerline, 731' MSL.

Trees and pole beginning 51' from DER, 16' right of centerline, up to 744' MSL.

Trees and building beginning 436' from DER, 3' left of centerline, up to 757' MSL.

Trees beginning 1284' from DER, 11' left of centerline, up to 775' MSL.

Trees beginning 1961' from DER, 27' right of centerline, up to 753' MSL.

**Rwy 36**, tree 983' from DER, 571' right of centerline, 754' MSL.

Tower 1.7 NM from DER, 1101' right of centerline, 292' AGL/973' MSL.

Tower 2.5 NM from DER, 4185' left of centerline, 420' AGL/1134' MSL.

## MT. GILEAD, OH

MORROW COUNTY (419)

TAKEOFF MINIMUMS AND (OBSTACLE) DEPARTURE PROCEDURES

AMDT 2 18NOV10 (10322)

TAKEOFF OBSTACLE NOTES:

**Rwy 10**, trees 858' from DER, 331' right of centerline, 100' AGL/1189' MSL.

Trees 963' from DER, 380' left of centerline, 100' AGL/1189' MSL.

**Rwy 28**, trees beginning 877' from DER, 302' right of centerline, up to 100' AGL/1159' MSL.

Trees 324' from DER, 494' right of centerline, 100' AGL/1169' MSL.

Vehicles on road beginning 228' from DER, extending from 542' right to 674' left of centerline up to 15' AGL/1084' MSL.

## MT. VERNON, OH

KNOX COUNTY (413)

TAKEOFF MINIMUMS AND (OBSTACLE) DEPARTURE PROCEDURES

ORIG 15JAN09 (09015) (FAA)

TAKEOFF OBSTACLE NOTES:

**Rwy 28**, trees 2121' from DER, 361' right of centerline, 47' AGL/1246' MSL.

## MUNCIE, IN

DELAWARE COUNTY RGNL (MIE)

TAKEOFF MINIMUMS AND (OBSTACLE) DEPARTURE PROCEDURES

AMDT 4A 12DEC13 (13346) (FAA)

TAKEOFF OBSTACLE NOTES:

**Rwy 3**, pole 717' from DER, 596' right of centerline, 19' AGL/954' MSL.

Trees beginning 771' from DER, 413' right of centerline, up to 56' AGL/991' MSL.

Trees beginning 2463' from DER, 44' left of centerline, up to 76' AGL/1007' MSL.

Towers and pole 3802' from DER, 702' left of centerline, up to 121' AGL/1049' MSL.

**Rwy 14**, trees beginning 2062' from DER, 1005' right of centerline, up to 68' AGL/1013' MSL.

**Rwy 21**, rising terrain beginning 6' from DER, 304' right of centerline, up to 943' MSL.

Flag pole 851' from DER, 627' left of centerline, 25' AGL/962' MSL.

Building 941' from DER, 670' left of centerline, 32' AGL/969' MSL.

Trees beginning 946' from DER, 39' left of centerline, up to 81' AGL/1033' MSL.

Trees beginning 1119' from DER, 207' right of centerline, up to 96' AGL/1032' MSL.

**Rwy 32**, trees and bushes beginning 86' from DER, 447' left of centerline, up to 17' AGL/940' MSL.

## NAPOLEON, OH

HENRY COUNTY (7W5)

TAKEOFF MINIMUMS AND (OBSTACLE) DEPARTURE PROCEDURES

ORIG 18NOV10 (10322) (FAA)

TAKEOFF OBSTACLE NOTES:

**Rwy 10**, trees 1128' from DER, 774' left of centerline, 100' AGL/784' MSL.

Trees 1910' from DER, 419' right of centerline, 100' AGL/784' MSL.

**Rwy 28**, vehicle on road 270' from DER, on centerline, 15' AGL/699' MSL.

Trees 575' from DER, 427' right of centerline, 100' AGL/784' MSL.

Trees 2140' from DER, 389' left of centerline, 100' AGL/789' MSL.

Trees 3167' from DER, 390' right of centerline, 100' AGL/784' MSL.

## NAPPANEE, IN

NAPPANEE MUNI (C03)

TAKEOFF MINIMUMS AND (OBSTACLE) DEPARTURE PROCEDURES

AMDT 1 19FEB81 (81036) (FAA)

TAKEOFF MINIMUMS:

**Rwy 9**, 300-1.

# TAKEOFF MINIMUMS, (OBSTACLE) DEPARTURE PROCEDURES, AND DIVERSE VECTOR AREA (RADAR VECTORS)

24025

# TAKEOFF MINIMUMS, (OBSTACLE) DEPARTURE PROCEDURES, AND DIVERSE VECTOR AREA (RADAR VECTORS)

24025

## NEW CASTLE, IN

### NEW CASTLE HENRY COUNTY MARLATT FLD (UWL)

#### TAKEOFF MINIMUMS AND (OBSTACLE) DEPARTURE PROCEDURES

AMDT 1A 20JUN19 (21224) (FAA)

##### TAKEOFF OBSTACLE NOTES:

**Rwy 10**, trees beginning 1657' from DER, 156' right of centerline, up to 1142' MSL.

Tree 1821' from DER, 92' left of centerline, 65' AGL/1146' MSL.

Trees beginning 1865' from DER, 22' right of centerline, up to 69' AGL/1153' MSL.

Tree 1931' from DER, 697' right of centerline, 1154' MSL.

Tree 1932' from DER, 817' right of centerline, 91' AGL/1176' MSL.

Trees beginning 1951' from DER, 571' right of centerline, up to 93' AGL/1179' MSL.

Trees beginning 2029' from DER, 530' right of centerline, up to 103' AGL/1190' MSL.

**Rwy 28**, pole, traverse way beginning 160' from DER, 464' right of centerline, up to 30' AGL/1101' MSL.

Pole beginning 346' from DER, 461' right of centerline, up to 32' AGL/1105' MSL.

Pole 444' from DER, 462' right of centerline, 35' AGL/1107' MSL.

## NEW LEXINGTON, OH

### PERRY COUNTY (I86)

#### TAKEOFF MINIMUMS AND (OBSTACLE) DEPARTURE PROCEDURES

ORIG 30AUG84 (84243) (FAA)

##### TAKEOFF MINIMUMS:

**Rwys 8, 26**, 300-1.

## NEW PHILADELPHIA, OH

### HARRY CLEVER FLD (PHD)

#### TAKEOFF MINIMUMS AND (OBSTACLE) DEPARTURE PROCEDURES

AMDT 3A 01FEB18 (22083) (FAA)

##### TAKEOFF MINIMUMS:

**Rwys 12, 30**, NA-Environmental.

**Rwy 15**, 500-2½ or std. w/min. climb to 420' per NM to 1500.

**Rwy 33**, std. w/min. climb of 210' per NM to 1500.

##### DEPARTURE PROCEDURE:

**Rwy 15**, climb heading 147° to 1500 before turning.

**Rwy 33**, climb heading 327° to 1600 before turning.

##### TAKEOFF OBSTACLE NOTES:

**Rwy 15**, poles beginning 194' from DER, 431' left of centerline, up to 56' AGL/935' MSL.

Vehicle on road beginning 240' from DER, 146' left of centerline, up to 15' AGL/902' MSL.

Rising terrain and trees beginning 320' from DER, 37' left of centerline, up to 100' AGL/1319' MSL.

Siren 383' from DER, 584' left of centerline, 81' AGL/940' MSL.

Tower 3659' from DER, 9' left of centerline, 124' AGL/983' MSL.

Vehicle on road beginning 78' from DER, 45' right of centerline, up to 15' AGL/904' MSL.

Trees beginning 79' from DER, 13' right of centerline, up to 100' AGL/972' MSL.

Poles beginning 678' from DER, 3' right of centerline, up to 61' AGL/920' MSL.

**Rwy 33**, trees beginning 41' from DER, 64' left of centerline, up to 100' AGL/965' MSL.

Vehicle on road beginning 108' from DER, 26' left of centerline, up to 15' AGL/914' MSL.

Headstone 142' from DER, 272' left of centerline, 6' AGL/900' MSL.

Building 167' from DER, 511' left of centerline, 34' AGL/928' MSL.

OL on pole 261' from DER, 213' left of centerline, 37' AGL/931' MSL.

Vehicle on road beginning 12' from DER, 28' right of centerline, up to 15' AGL/914' MSL.

Rising terrain and trees beginning 36' from DER, 22' right of centerline, up to 100' AGL/984' MSL.

Fence 83' from DER, 217' right of centerline, 6' AGL/900' MSL.

Poles beginning 502' from DER, 368' right of centerline, up to 28' AGL/924' MSL.

Tower 2.6 NM from DER, 2107' right of centerline, 406' AGL/1319' MSL.

## NEWARK, OH

### NEWARK-HEATH (VTA)

#### TAKEOFF MINIMUMS AND (OBSTACLE) DEPARTURE PROCEDURES

AMDT 3 20JUN19 (19171) (FAA)

##### TAKEOFF MINIMUMS:

**Rwy 9**, 600-3 w/min. climb of 225' per NM to 1700 or std. w/min climb of 300' per NM to 1600 or 1000-3 for VCOA.

**Rwy 27**, 400-2½ or std. w/min. climb of 220' per NM to 1200.

##### DEPARTURE PROCEDURE:

**Rwy 9**, climb heading 093° to 1700 before proceeding on course.

**Rwy 27**, climb on heading 273° to 1400 before proceeding on course.

##### VCOA:

**Rwy 9**, obtain ATC approval for VCOA when requesting IFR clearance. Climb in visual conditions to cross Newark-Heath Airport at or above 1700 before proceeding on course.

##### CON'T

# TAKEOFF MINIMUMS, (OBSTACLE) DEPARTURE PROCEDURES, AND DIVERSE VECTOR AREA (RADAR VECTORS)

24025

EC-2

# TAKEOFF MINIMUMS, (OBSTACLE) DEPARTURE PROCEDURES, AND DIVERSE VECTOR AREA (RADAR VECTORS)

24025

## NEWARK, OH (CON'T) NEWARK-HEATH (VTA) (CON'T)

### TAKEOFF OBSTACLE NOTES:

**Rwy 9**, tree, terrain beginning 25' from DER, 173' left of centerline, up to 889' MSL.  
 Lighting 40' from DER, 77' right of centerline, 871' MSL.  
 Building 93' from DER, 510' right of centerline, 879' MSL.  
 Transmission line, fence beginning 105' from DER, 249' right of centerline, up to 907' MSL.  
 Trees, poles, building beginning 107' from DER, 454' left of centerline, up to 71' AGL/934' MSL.  
 Tree 237' from DER, 554' right of centerline, 922' MSL.  
 Trees, pole beginning 558' from DER, 29' right of centerline, up to 942' MSL.  
 Tree 2651' from DER, 263' right of centerline, 949' MSL.  
 Trees beginning 2741' from DER, 473' right of centerline, up to 953' MSL.  
 Tree 4800' from DER, 1713' right of centerline, 1005' MSL.  
 Trees beginning 4884' from DER, 1409' right of centerline, up to 1008' MSL.  
 Trees, buildings beginning 5018' from DER, 1522' right of centerline, up to 1018' MSL.  
 Trees, building beginning 5164' from DER, 1437' right of centerline, up to 1032' MSL.  
 Trees, buildings beginning 5288' from DER, 1367' right of centerline, up to 1041' MSL.  
 Trees, building beginning 5679' from DER, 1429' right of centerline, up to 1055' MSL.  
 Trees beginning 5909' from DER, 1352' right of centerline, up to 1058' MSL.  
 Tree 1 NM from DER, 1488' right of centerline, 1065' MSL.  
 Trees, building beginning 1 NM from DER, 1429' right of centerline, up to 1076' MSL.  
 Trees beginning 1 NM from DER, 1430' right of centerline, up to 1101' MSL.  
 Trees beginning 1 NM from DER, 1834' right of centerline, up to 1110' MSL.  
 Trees beginning 1.1 NM from DER, 1580' right of centerline, up to 69' AGL/1118' MSL.  
**Rwy 9 (CON'T)**, trees beginning 1.1 NM from DER, 1546' right of centerline, up to 1120' MSL.  
 Trees, building beginning 1.1 NM from DER, 1318' right of centerline, up to 1121' MSL.  
 Trees beginning 1.1 NM from DER, 1230' right of centerline, up to 1122' MSL.  
 Trees buildings beginning 1.1 NM from DER, 1399' right of centerline, up to 1125' MSL.  
 Trees beginning 1.3 NM from DER, 1932' right of centerline, up to 1130' MSL.  
 Tree 1.3 NM from DER, 2058' right of centerline, 1132' MSL.  
 Trees, buildings beginning 1.3 NM from DER, 297' right of centerline, up to 90' AGL/1151' MSL.  
 Trees beginning 1.3 NM from DER, 223' left of centerline, up to 1121' MSL.  
 Trees beginning 1.3 NM from DER, 168' left of centerline, up to 1127' MSL.  
 Trees beginning 1.3 NM from DER, 66' left of centerline, up to 1150' MSL.  
 Trees beginning 1.4 NM from DER, 62' left of centerline, up to 151' AGL/1151' MSL.  
 Trees beginning 1.6 NM from DER, 659' right of centerline, up to 1163' MSL.  
 Trees beginning 1.6 NM from DER, 8' right of centerline, up to 1168' MSL.  
 Trees, building beginning 1.6 NM from DER, 107' right of centerline, up to 82' AGL/1179' MSL.  
 Antenna 2.4 NM from DER, 2425' left of centerline, 360' AGL/1394' MSL.  
 Tower 2.4 NM from DER, 2371' left of centerline, 362' AGL/1396' MSL.  
 Antenna 2.4 NM from DER, 2430' left of centerline, 360' AGL/1396' MSL.  
**Rwy 27**, terrain 2' from DER, 251' right of centerline, 884' MSL.  
 Terrain 11' from DER, 486' right of centerline, 886' MSL.  
 Pole, vehicles on road beginning 49' from DER, 199' left of centerline, up to 910' MSL.  
 Pole, vehicles on road beginning 188' from DER, 32' left of centerline, up to 29' AGL/912' MSL.  
 Trees, poles, bldg twr beginning 543' from DER, 120' left of centerline, up to 968' MSL.  
 Vehicles on road 604' from DER, 31' right of centerline, 902' MSL.  
 Pole 697' from DER, 139' right of centerline, 919' MSL.  
 Poles, building beginning 796' from DER, 206' right of centerline, up to 920' MSL.  
 Pole 972' from DER, 313' right of centerline, 926' MSL.  
 Trees beginning 1033' from DER, 11' right of centerline, up to 933' MSL.  
 Trees, pole beginning 1196' from DER, 64' right of centerline, up to 963' MSL.  
 Tree 1533' from DER, 7' right of centerline, 971' MSL.  
 Tree 1591' from DER, 682' right of centerline, 973' MSL.  
 Trees beginning 1645' from DER, 189' right of centerline, up to 976' MSL.  
 Trees beginning 1750' from DER, 321' right of centerline, up to 979' MSL.  
 Trees, poles beginning 2005' from DER, 58' right of centerline, up to 985' MSL.  
 Tree, poles beginning 2270' from DER, 154' left of centerline, up to 970' MSL.  
 Tree 3354' from DER, 1131' right of centerline, 993' MSL.  
 Tree 3381' from DER, 384' left of centerline, 974' MSL.  
 Tree 3776' from DER, 1384' left of centerline, 983' MSL.  
 Tree 3791' from DER, 1212' right of centerline, 996' MSL.  
 Tree 3892' from DER, 1160' right of centerline, 998' MSL.  
 Tree 3899' from DER, 1424' left of centerline, 992' MSL.  
 Tree 3984' from DER, 1537' left of centerline, 994' MSL.  
 Trees beginning 4015' from DER, 1135' right of centerline, up to 1003' MSL.  
 Trees beginning 4020' from DER, 1325' left of centerline, up to 998' MSL.  
 Trees beginning 4550' from DER, 755' left of centerline, up to 1009' MSL.  
 Tree 4739' from DER, 913' left of centerline, 1011' MSL.  
 Trees beginning 4835' from DER, 634' left of centerline, up to 1021' MSL.  
 Trees beginning 4982' from DER, 966' left of centerline, up to 1029' MSL.  
 Tree 1.3 NM from DER, 1932' right of centerline, 1094' MSL.  
 Tree 1.3 NM from DER, 2173' right of centerline, 1099' MSL.  
 Trees beginning 1.3 NM from DER, 1874' right of centerline, up to 1109' MSL.  
 Tree 2.1 NM from DER, 2988' right of centerline, 121' AGL/1204' MSL.

22 FEB 2024 to 21 MAR 2024

22 FEB 2024 to 21 MAR 2024

# TAKEOFF MINIMUMS, (OBSTACLE) DEPARTURE PROCEDURES, AND DIVERSE VECTOR AREA (RADAR VECTORS)

24025

EC-2

# TAKEOFF MINIMUMS, (OBSTACLE) DEPARTURE PROCEDURES, AND DIVERSE VECTOR AREA (RADAR VECTORS)

24025

## NORTH VERNON, IN

### NORTH VERNON (OVO)

#### TAKEOFF MINIMUMS AND (OBSTACLE) DEPARTURE PROCEDURES

ORIG 27AUG09 (09239) (FAA)

#### TAKEOFF OBSTACLE NOTES:

- Rwy 5**, tree 1866' from DER, 690' left of centerline, 62' AGL/821' MSL.
- Tree 428' from DER, 516' right of centerline, 22' AGL/781' MSL.
- Rwy 15**, fence beginning 259' from DER, crossing left to right, 11' AGL/765' MSL.
- Trees beginning 469' from DER, 100' left of centerline, up to 115' AGL/864' MSL.
- Tree 1509' from DER, 472' right of centerline, 59' AGL/818' MSL.
- Rwy 23**, trees beginning 1856' from DER, 94' left of centerline, up to 93' AGL/842' MSL.
- Tree 3348' from DER 675' right of centerline, 97' AGL/846' MSL.
- Rwy 33**, fence beginning 304' from DER, 138' left of centerline, 11' AGL/761' MSL.
- Tree 2592' from DER, 596' left of centerline, 90' AGL/839' MSL.
- Power pole 751' from DER, 102' right of centerline, 25' AGL/774' MSL.

## NORWALK, OH

### NORWALK-HURON COUNTY (5A1)

#### TAKEOFF MINIMUMS AND (OBSTACLE) DEPARTURE PROCEDURES

AMDT 2 03NOV22 (22307) (FAA)

#### TAKEOFF OBSTACLE NOTES:

- Rwy 10**, vegetation 24' from DER, 253' left of centerline, 853' MSL.
- Tree 47' from DER, 455' right of centerline, 894' MSL.
- Poles, traverse ways, fence, trees beginning 92' from DER, 243' right of centerline, up to 61' AGL/918' MSL.
- Poles, trees, traverse way, building beginning 461' from DER, 189' right of centerline, up to 929' MSL.
- Trees beginning 673' from DER, 247' left of centerline, up to 914' MSL.
- Trees beginning 719' from DER, 210' left of centerline, up to 93' AGL/939' MSL.
- Trees beginning 852' from DER, 178' right of centerline, up to 930' MSL.
- Trees, pole beginning 855' from DER, 197' left of centerline, up to 104' AGL/950' MSL.
- Trees beginning 1013' from DER, 200' left of centerline, up to 103' AGL/953' MSL.
- Trees beginning 1217' from DER, 40' left of centerline, up to 103' AGL/955' MSL.
- Trees beginning 1799' from DER, 230' right of centerline, up to 75' AGL/931' MSL.
- Trees beginning 2482' from DER, 260' right of centerline, up to 72' AGL/933' MSL.
- Trees beginning 2645' from DER, 16' left of centerline, up to 956' MSL.
- Trees beginning 3125' from DER, 5' right of centerline, up to 945' MSL.
- Trees beginning 3240' from DER, 13' left of centerline, up to 102' AGL/959' MSL.
- Tree 3272' from DER, 325' left of centerline, 105' AGL/963' MSL.
- Trees beginning 3276' from DER, 17' left of centerline, up to 109' AGL/967' MSL.
- Trees beginning 3303' from DER, 1' left of centerline, up to 112' AGL/975' MSL.
- Trees beginning 3346' from DER, 40' right of centerline, up to 85' AGL/947' MSL.
- Tree 3385' from DER, 47' right of centerline, 83' AGL/948' MSL.
- Trees beginning 3391' from DER, 8' right of centerline, up to 93' AGL/954' MSL.
- Trees beginning 3494' from DER, 21' right of centerline, up to 86' AGL/956' MSL.
- Trees beginning 3495' from DER, 11' right of centerline, up to 93' AGL/962' MSL.
- Tree 3515' from DER, 23' right of centerline, 93' AGL/963' MSL.
- Trees beginning 3532' from DER, 12' right of centerline, up to 96' AGL/966' MSL.
- Trees beginning 3599' from DER, 3' right of centerline, up to 97' AGL/969' MSL.
- Tree 4933' from DER, 1799' right of centerline, 976' MSL.
- Rwy 28**, tree 50' from DER, 344' left of centerline, 937' MSL.
- Trees beginning 55' from DER, 192' right of centerline, up to 15' AGL/846' MSL.
- Trees, vegetation, tower beginning 95' from DER, 116' left of centerline, up to 100' AGL/940' MSL.
- Trees beginning 120' from DER, 182' right of centerline, up to 847' MSL.
- Tree 1298' from DER, 841' right of centerline, 901' MSL.
- Trees beginning 1448' from DER, 830' right of centerline, up to 907' MSL.

## OTTAWA, OH

### PUTNAM COUNTY (OWX)

#### TAKEOFF MINIMUMS AND (OBSTACLE) DEPARTURE PROCEDURES

ORIG 27AUG09 (09239) (FAA)

#### TAKEOFF OBSTACLE NOTES:

- Rwy 9**, trees 1342' from DER, 578' right of centerline, 100' AGL/854' MSL.
- Tree 1978' from DER, 5' left of centerline, 50' AGL/814' MSL.
- Rwy 27**, road 1' from DER, 219' right of centerline, 15' AGL/768' MSL.
- Multiple trees and pole beginning 1606' from DER, 303' left of centerline, up to 100' AGL/854' MSL.

# TAKEOFF MINIMUMS, (OBSTACLE) DEPARTURE PROCEDURES, AND DIVERSE VECTOR AREA (RADAR VECTORS)

24025

EC-2

# TAKEOFF MINIMUMS, (OBSTACLE) DEPARTURE PROCEDURES, AND DIVERSE VECTOR AREA (RADAR VECTORS)

24025

## OXFORD, OH

MIAMI UNIVERSITY (OXD)

TAKEOFF MINIMUMS AND (OBSTACLE) DEPARTURE PROCEDURES

AMDT 2 31MAY12 (12152) (FAA)

TAKEOFF OBSTACLE NOTES:

**Rwy 5**, trees beginning 314' from DER, left and right of centerline, up to 100' AGL/1129' MSL.

Vehicles on roadway beginning 320' from DER, 282' right of centerline, up to 15' AGL/1044' MSL.

Poles beginning 695' from DER, 209' left of centerline, up to 35' AGL/1061' MSL.

Rod on building 764' from DER, 501' left of centerline, 33' AGL/1060' MSL.

Light poles beginning 966' from DER, 518' right of centerline, up to 70' AGL/1084' MSL.

**Rwy 23**, vehicles on roadway beginning 136' from DER, left and right of centerline, up to 15' AGL/1054' MSL.

Poles beginning 139' from DER, 178' left of centerline, up to 33' AGL/1072' MSL.

Trees beginning 256' from DER, left and right of centerline, up to 100' AGL/1149' MSL.

Buildings beginning 269' from DER, left and right of centerline, up to 33' AGL/1068' MSL.

Chimney 327' from DER, 432' left of centerline, 34' AGL/ 1070' MSL.

Antenna 1076' from DER, 243' left of centerline, 43' AGL/1073' MSL.

## PAINESVILLE, OH

CONCORD AIRPARK (2G1)

TAKEOFF MINIMUMS AND (OBSTACLE) DEPARTURE PROCEDURES

AMDT 3A 11AUG22 (22223) (FAA)

TAKEOFF MINIMUMS:

**Rwy 21**, 400-2½ or std. w/min. climb of 400' per NM to 1500.

DEPARTURE PROCEDURE:

**Rwy 21**, climb on heading 209° to 1500 before proceeding on course.

TAKEOFF OBSTACLE NOTES:

**Rwy 3**, trees beginning 336' from DER, 42' left of centerline, up to 100' AGL/1039' MSL.

Trees beginning 1064' from DER, 217' right of centerline, up to 100' AGL/1039' MSL.

**Rwy 21**, trees beginning 131' from DER, left and right of centerline, up to 100' AGL/1220' MSL.

Tower 1.2 NM from DER, 2020' right of centerline, 114' AGL/1223' MSL.

## PERU, IN

PERU MUNI (I76)

TAKEOFF MINIMUMS AND (OBSTACLE) DEPARTURE PROCEDURES

AMDT 3 18JAN07 (07018) (FAA)

TAKEOFF OBSTACLE NOTES:

**Rwy 1**, multiple trees beginning 2201' from DER, 321' left of centerline, 100' AGL/879' MSL.

Road plus vehicle beginning 407' from DER, 1524' right of centerline, 15' AGL/794' MSL.

Trees beginning 1656' from DER, 815' right of centerline, 100' AGL/879' MSL.

**Rwy 19**, multiple trees beginning 44' from DER, 204' left of centerline, 100' AGL/869' MSL.

Multiple trees beginning 588' from DER, 134' right of centerline, 100' AGL/859' MSL.

## PIQUA, OH

PIQUA/HARTZELL FLD (I17)

TAKEOFF MINIMUMS AND (OBSTACLE) DEPARTURE PROCEDURES

ORIG 20OCT11 (21224) (FAA)

TAKEOFF OBSTACLE NOTES:

**Rwy 8**, tree 2006' from DER, 515' left of centerline, 76' AGL/1062' MSL.

**Rwy 26**, vehicles on roadway, beginning 347' from DER, 578' left of centerline, up to 15' AGL/1024' MSL.

Trees and grain bin beginning 61' from DER, 321' left of centerline, up to 100' AGL/1119' MSL.

## PLYMOUTH, IN

PLYMOUTH MUNI (C65)

TAKEOFF MINIMUMS AND (OBSTACLE) DEPARTURE PROCEDURES

ORIG 18JUL74 (74199) (FAA)

TAKEOFF MINIMUMS:

**Rwys 10, 28**, 300-1.

## PORT CLINTON, OH

ERIE-OTTAWA INTL (PCW)

TAKEOFF MINIMUMS AND (OBSTACLE) DEPARTURE PROCEDURES

AMDT 6A 12NOV15 (22223) (FAA)

TAKEOFF MINIMUMS:

**Rwy 27**, std. w/min. climb of 250' per NM to 1600 or 1000-2½ for climb in visual conditions.

DEPARTURE PROCEDURE:

**Rwy 27**, for climb in visual conditions: cross Erie-Ottawa Intl at or above 1400 MSL before proceeding on course.

TAKEOFF OBSTACLE NOTES:

**Rwy 9**, multiple trees and poles beginning 417' from DER, 398' left of centerline, up to 78' AGL/668' MSL.

Multiple trees and poles beginning 407' from DER, 550' right of centerline, up to 67' AGL/657' MSL.

CON'T

# TAKEOFF MINIMUMS, (OBSTACLE) DEPARTURE PROCEDURES, AND DIVERSE VECTOR AREA (RADAR VECTORS)

24025

EC-2



# TAKEOFF MINIMUMS, (OBSTACLE) DEPARTURE PROCEDURES, AND DIVERSE VECTOR AREA (RADAR VECTORS)

24025

## PORT CLINTON, OH (CON'T)

### ERIE-OTTAWA INTL (PCW) (CON'T)

**Rwy 18**, multiple trees beginning 626' from DER, 424' left of centerline, up to 100' AGL/684' MSL.

Trees 511' from DER, 471' right of centerline, 100' AGL/684' MSL.

Vehicles on road 475' from DER, 31' right of centerline, 15' AGL/604' MSL.

**Rwy 27**, multiple trees beginning 1210' from DER, 176' left of centerline, up to 65' AGL/650' MSL.

Pole 1066' from DER, 609' right of centerline, 35' AGL/620' MSL.

Multiple trees beginning 2558' from DER, 311' right of centerline, up to 91' AGL/676' MSL.

**Rwy 36**, trees 558' from DER, 406' left of centerline, 100' AGL/684' MSL.

Trees 770' from DER, 564' right of centerline, 100' AGL/679' MSL.

Trees 5097' from DER, 1661' right of centerline, 100' AGL/719' MSL.

## PORTLAND, IN

### PORTLAND MUNI (PLD)

#### TAKEOFF MINIMUMS AND (OBSTACLE) DEPARTURE PROCEDURES

AMDT 1 23FEB23 (23054) (FAA)

##### TAKEOFF OBSTACLE NOTES:

**Rwy 9**, poles, fence beginning 29' from DER, 348' right of centerline, up to 29' AGL/956' MSL.

Tree 69' from DER, 492' left of centerline, 943' MSL.

Tree 102' from DER, 523' left of centerline, 41' AGL/964' MSL.

Trees, poles, building beginning 226' from DER, 13' left of centerline, up to 51' AGL/972' MSL.

Pole 349' from DER, 581' right of centerline, 42' AGL/969' MSL.

Trees, poles beginning 571' from DER, 80' right of centerline, up to 53' AGL/979' MSL.

Trees beginning 1635' from DER, 521' right of centerline, up to 985' MSL.

Tree 1818' from DER, 542' right of centerline, 71' AGL/994' MSL.

Trees beginning 1848' from DER, 520' right of centerline, up to 1003' MSL.

Trees beginning 2268' from DER, 519' right of centerline, up to 1015' MSL.

Tree 2475' from DER, 619' right of centerline, 1016' MSL.

Trees, transmission lines beginning 2517' from DER, 100' right of centerline, up to 1018' MSL.

Trees beginning 2780' from DER, 37' left of centerline, up to 1008' MSL.

Tree 2813' from DER, 48' right of centerline, 1020' MSL.

Trees beginning 2821' from DER, 471' right of centerline, up to 1023' MSL.

Trees beginning 2833' from DER, 233' right of centerline, up to 1025' MSL.

Trees beginning 2908' from DER, 113' right of centerline, up to 1032' MSL.

Trees beginning 2940' from DER, 63' left of centerline, up to 102' AGL/1024' MSL.

Trees beginning 2943' from DER, 71' right of centerline, up to 113' AGL/1035' MSL.

Trees beginning 2967' from DER, 16' left of centerline, up to 1030' MSL.

Trees beginning 3186' from DER, 20' right of centerline, up to 1037' MSL.

## PORTSMOUTH, OH

### GREATER PORTSMOUTH RGNL (PMH)

#### TAKEOFF MINIMUMS AND (OBSTACLE) DEPARTURE PROCEDURES

AMDT 3 31MAY12 (12152) (FAA)

##### TAKEOFF MINIMUMS:

**Rwy 18**, 300-1% or std. w/min. climb of 257' per NM to 1100.

##### DEPARTURE PROCEDURE:

**Rwy 18**, climb heading 170° to 1300 before proceeding on course.

##### TAKEOFF OBSTACLE NOTES:

**Rwy 18**, trees beginning 4' from DER, 290' left of centerline, up to 100' AGL/721' MSL.

Trees beginning 678' from DER, 495' right of centerline, up to 100' AGL/931' MSL.

**Rwy 36**, trees beginning 1' from DER, 180' left of centerline, up to 100' AGL/780' MSL.

Trees beginning 687' from DER, 388' right of centerline, up to 100' AGL/710' MSL.

## RAVENNA, OH

### PORTAGE COUNTY (POV)

#### TAKEOFF MINIMUMS AND (OBSTACLE) DEPARTURE PROCEDURES

ORIG 18NOV10 (10322) (FAA)

##### TAKEOFF OBSTACLE NOTES:

**Rwy 9**, power poles and road 19' from DER, 368' left of centerline, up to 35' AGL/1238' MSL.

Power pole 413' from DER, 549' right of centerline, 35' AGL/1218' MSL.

**Rwy 27**, tree 751' from DER, 148' right of centerline, 56' AGL/1226' MSL.

Pole 105' from DER, 523' right of centerline, 35' AGL/1200' MSL.

Power poles 357' from DER, 408' left of centerline, up to 35' AGL/1244' MSL.

# TAKEOFF MINIMUMS, (OBSTACLE) DEPARTURE PROCEDURES, AND DIVERSE VECTOR AREA (RADAR VECTORS)

24025

# TAKEOFF MINIMUMS, (OBSTACLE) DEPARTURE PROCEDURES, AND DIVERSE VECTOR AREA (RADAR VECTORS)

24025

## RENSSELAER, IN

### JASPER COUNTY (RZL)

#### TAKEOFF MINIMUMS AND (OBSTACLE) DEPARTURE PROCEDURES

AMDT 1A 11AUG22 (22223) (FAA)

#### TAKEOFF MINIMUMS:

Rwys 18, 36, 300-1.

Rwys 9, 27, NA-Environmental.

#### DEPARTURE PROCEDURE:

Rwys 18, 36, climb to 1100 on runway heading before proceeding on course.

## RICHMOND, IN

### RICHMOND MUNI (RID)

#### TAKEOFF MINIMUMS AND (OBSTACLE) DEPARTURE PROCEDURES

ORIG-A 11AUG22 (22223) (FAA)

#### TAKEOFF OBSTACLE NOTES:

Rwy 6, NAVAID 10' from DER, 150' left of centerline, 3' AGL/1140' MSL.

Terrain 27' from DER, 177' right of centerline, 1139' MSL.

Terrain beginning 54' from DER, 175' right of centerline, up to 1145' MSL.

Terrain 156' from DER, 472' right of centerline, 1147' MSL.

Tree 667' from DER, 677' left of centerline, 1160' MSL.

Tree 1704' from DER, 797' left of centerline, 1209' MSL.

Trees beginning 1774' from DER, 701' left of centerline, up to 1217' MSL.

Rwy 15, terrain 91' from der, 306' left of centerline, 1145' MSL.

Terrain beginning 93' from DER, 111' left of centerline, up to 1146' MSL.

Tree 2551' from DER, 111' left of centerline, 68' AGL/1208' MSL.

Trees beginning 2573' from DER, 0' left of centerline, up to 75' AGL/1216' MSL.

Trees beginning 2967' from DER, 150' right of centerline, up to 86' AGL/1226' MSL.

Rwy 24, terrain 35' from DER, 321' left of centerline, 1140' MSL.

Terrain beginning 106' from DER, 120' left of centerline, up to 1142' MSL.

Pole, building, traverse way beginning 274' from DER, 276' right of centerline, up to 21' AGL/1148' MSL.

Traverse way 465' from DER, 324' right of centerline, 1149' MSL.

Traverse way 665' from DER, 29' right of centerline, 1156' MSL.

Tree 1084' from DER, 685' left of centerline, 1175' MSL.

Trees beginning 1128' from DER, 525' left of centerline, up to 51' AGL/1177' MSL.

Trees beginning 1377' from DER, 758' left of centerline, up to 68' AGL/1190' MSL.

Rwy 33, terrain 17' from DER, 483' right of centerline, 1128' MSL.

Traverse way 351' from DER, 578' right of centerline, 1141' MSL.

Tree 434' from DER, 490' right of centerline, 1186' MSL.

Trees beginning 484' from DER, 34' right of centerline, up to 1190' MSL.

Trees beginning 1046' from DER, 358' left of centerline, up to 87' AGL/1198' MSL.

Trees, tower, building beginning 1085' from DER, 17' left of centerline, up to 1200' MSL.

Trees beginning 1742' from DER, 771' right of centerline, up to 1196' MSL.

## ROCHESTER, IN

### FULTON COUNTY (RCR)

#### TAKEOFF MINIMUMS AND (OBSTACLE) DEPARTURE PROCEDURES

ORIG 25SEP08 (08269) (FAA)

#### TAKEOFF OBSTACLE NOTES:

Rwy 11, terrain 469' right of centerline, 797' MSL.

Trees beginning 619' from DER, 181' right of centerline, up to 105' AGL/894' MSL.

Trees beginning 2534' from DER, 27' left of centerline, up to 97' AGL/886' MSL.

Rwy 29, pole 1' from DER, 480' left of centerline, 28' AGL/817' MSL.

Pole 195' from DER, 460' left of centerline, 28' AGL/817' MSL.

Pole 524' from DER, 503' left of centerline, 33' AGL/823' MSL.

Vehicle on road 578' from DER, 100' left of centerline, 15' AGL/804' MSL.

Vent on building 890' from DER, 262' left of centerline, 23' AGL/812' MSL.

Trees beginning 614' from DER, 355' left of centerline, up to 87' AGL/876' MSL.

Vent on building 229' from DER, 525' right of centerline, 40' AGL/829' MSL.

Pole 843' from DER, 94' right of centerline, 23' AGL/812' MSL.

Trees beginning 883' from DER, 152' right of centerline, up to 103' AGL/892' MSL.

22 FEB 2024 to 21 MAR 2024

22 FEB 2024 to 21 MAR 2024

# TAKEOFF MINIMUMS, (OBSTACLE) DEPARTURE PROCEDURES, AND DIVERSE VECTOR AREA (RADAR VECTORS)

24025

EC-2

# TAKEOFF MINIMUMS, (OBSTACLE) DEPARTURE PROCEDURES, AND DIVERSE VECTOR AREA (RADAR VECTORS)

24025

## ST. CLAIRSVILLE, OH

### ALDERMAN (2P7)

#### TAKEOFF MINIMUMS AND (OBSTACLE) DEPARTURE PROCEDURES

AMDT 3 16DEC10 (10350) (FAA)

##### TAKEOFF MINIMUMS:

**Rwy 1**, 300-1¼ or std. w/min. climb of 395' per NM to 1800.

**Rwy 19**, 500-3 or std. w/min. climb of 244' per NM to 1800.

##### DEPARTURE PROCEDURE:

**Rwy 1**, climb heading 013° to 1800 before turning right.

**Rwy 19**, climb heading 193° to 1800 before proceeding on course.

##### TAKEOFF OBSTACLE NOTES:

**Rwy 1**, trees 49' from DER, 170' left of centerline, up to 90' AGL/1269' MSL.

Trees 179' from DER, 53' left of centerline, up to 90' AGL/1249' MSL.

Trees 210' from DER, 37' right of centerline, up to 90' AGL/1249' MSL.

**Rwy 19**, trees 141' from DER, 138' left of centerline, up to 90' AGL/1229' MSL.

Trees 154' from DER, 168' right of centerline up to 90' AGL/1249' MSL.

Trees 385' from DER, 34' right of centerline, up to 90' AGL/1229' MSL.

Trees 1764' from DER, 958' right of centerline, up to 90' AGL/1309' MSL.

## SALEM, OH

### SALEM AIRPARK (38D)

#### TAKEOFF MINIMUMS AND (OBSTACLE) DEPARTURE PROCEDURES

AMDT 2 24MAY18 (24025) (FAA)

##### TAKEOFF MINIMUMS:

**Rwys 10R, 28L**, NA-Environmental.

**Rwy 10L**, std w/min climb of 217' per NM to 1800, or 1400-3 for VCOA.

##### DEPARTURE PROCEDURE:

**Rwy 28R**, climb on heading 277° to 2200 before turning left.

##### VCOA:

**Rwy 10L**, obtain ATC approval for VCOA when requesting IFR clearance. Climb in visual conditions to cross Salem Airpark at or above 2400 before proceeding on course.

##### TAKEOFF OBSTACLE NOTES:

**Rwy 10L**, tower, 3186' from DER, 654' left of centerline, 72' AGL/1305' MSL.

## SEBRING, OH

### TRI-CITY (3G6)

#### TAKEOFF MINIMUMS AND (OBSTACLE) DEPARTURE PROCEDURES

ORIG-A 17JUN21 (22307) (FAA)

##### DEPARTURE PROCEDURE:

**Rwy 18**, climb on heading 181° to 3000 before turning east.

**Rwy 36**, climb on heading 001° to 3000 before turning east.

##### TAKEOFF OBSTACLE NOTES:

**Rwy 18**, trees 146' from DER, 451' right of centerline, 100' AGL/1242' MSL.

Trees beginning 179' from DER, 39' right of centerline, up to 100' AGL/1262' MSL.

Trees, pole beginning 212' from DER, 4' left of centerline, up to 100' AGL/1262' MSL.

**Rwy 36**, trees beginning 23' from DER, 31' right of centerline, up to 100' AGL/1272' MSL.

Trees beginning 90' from DER, 12' left of centerline, up to 100' AGL/1262' MSL.

22 FEB 2024 to 21 MAR 2024

22 FEB 2024 to 21 MAR 2024

# TAKEOFF MINIMUMS, (OBSTACLE) DEPARTURE PROCEDURES, AND DIVERSE VECTOR AREA (RADAR VECTORS)

24025

EC-2

# TAKEOFF MINIMUMS, (OBSTACLE) DEPARTURE PROCEDURES, AND DIVERSE VECTOR AREA (RADAR VECTORS)

24025

## SEYMOUR, IN

### FREEMAN MUNI (SER)

#### TAKEOFF MINIMUMS AND (OBSTACLE) DEPARTURE PROCEDURES

AMDT 1 08SEP22 (22251) (FAA)

#### DEPARTURE PROCEDURE:

**Rwy 5**, climb on heading 046° to 1100 before turning left.

**Rwy 14**, climb on heading 136° to 1100 before turning right.

#### TAKEOFF OBSTACLE NOTES:

**Rwy 5**, tree 1624' from DER, 755' left of centerline, 52' AGL/631' MSL.

Tree 1706' from DER, 793' left of centerline, 637' MSL.

Trees beginning 1713' from DER, 524' left of centerline, up to 98' AGL/677' MSL.

Tree 2018' from DER, 757' right of centerline, 51' AGL/631' MSL.

Tree 2088' from DER, 708' right of centerline, 69' AGL/650' MSL.

Tree 2114' from DER, 689' right of centerline, 71' AGL/652' MSL.

Trees beginning 3614' from DER, 1055' left of centerline, up to 685' MSL.

**Rwy 14**, lighting beginning 10' from DER, 30' left of centerline, up to 2' AGL/572' MSL.

Lighting 40' from DER, 123' right of centerline, 2' AGL/572' MSL.

Lighting 50' from DER, 94' right of centerline, 3' AGL/573' MSL.

Tree 2220' from DER, 271' right of centerline, 642' MSL.

Trees beginning 2287' from DER, 442' right of centerline, up to 656' MSL.

Trees beginning 2347' from DER, 326' right of centerline, up to 662' MSL.

Trees beginning 2376' from DER, 353' right of centerline, up to 666' MSL.

Trees beginning 2426' from DER, 292' right of centerline, up to 670' MSL.

Trees beginning 2517' from DER, 390' right of centerline, up to 672' MSL.

Trees beginning 2611' from DER, 403' right of centerline, up to 673' MSL.

**Rwy 23**, tree 1906' from DER, 882' left of centerline, 623' MSL.

Tree 2001' from DER, 855' left of centerline, 635' MSL.

Tree 2117' from DER, 729' left of centerline, 643' MSL.

Trees beginning 2241' from DER, 461' left of centerline, up to 644' MSL.

Trees beginning 2400' from DER, 458' left of centerline, up to 652' MSL.

Trees beginning 2437' from DER, 172' left of centerline, up to 658' MSL.

**Rwy 32**, lighting beginning 10' from DER, 30' left of centerline, up to 2' AGL/585' MSL.

Lighting beginning 10' from DER, 30' right of centerline, up to 2' AGL/585' MSL.

Tree 2340' from DER, 401' left of centerline, 57' AGL/647' MSL.

Trees beginning 2392' from DER, 357' left of centerline, up to 71' AGL/662' MSL.

Trees beginning 2647' from DER, 882' left of centerline, up to 668' MSL.

## SHELBY, OH

### SHELBY COMMUNITY (12G)

#### TAKEOFF MINIMUMS AND (OBSTACLE) DEPARTURE PROCEDURES

AMDT 2A 15AUG19 (19227) (FAA)

#### TAKEOFF MINIMUMS:

**Rwys 3, 21**, NA-Environmental.

#### TAKEOFF OBSTACLE NOTES:

**Rwy 18**, trees beginning 9' from DER, 171' left of centerline, up to 100' AGL/1219' MSL.

Vehicles beginning 24' from DER, 303' left of centerline, up to 15' AGL/1134' MSL.

Trees beginning 338' from DER, 447' right of centerline, up to 100' AGL/1229' MSL.

Transmission line beginning 2127' from DER, 170' left and right of centerline, up to 91' AGL/1200' MSL.

**Rwy 36**, vehicles beginning 30' from DER, left and right of centerline, up to 17' AGL/1136' MSL.

Buildings beginning 63' from DER, left and right of centerline, up to 53' AGL/1172' MSL.

Trees beginning 561' from DER, 85' left of centerline, up to 100' AGL/1209' MSL.

Grain silos beginning 1799' from DER, 225' right of centerline, up to 100' AGL/1229' MSL.

## SHELBYVILLE, IN

### SHELBYVILLE MUNI (GEZ)

#### TAKEOFF MINIMUMS AND (OBSTACLE) DEPARTURE PROCEDURES

AMDT 5 20OCT11 (11293) (FAA)

#### TAKEOFF MINIMUMS:

**Rwys 9, 27**, NA-Environmental.

#### TAKEOFF OBSTACLE NOTES:

**Rwy 1**, trees 1111' from DER, 753' right of centerline, 69' AGL/869' MSL.

**Rwy 19**, trees 2180' from DER, 261' right of centerline, 100' AGL/899' MSL.

Trees 2696' from DER, 498' left of centerline, 100' AGL/899' MSL.

# TAKEOFF MINIMUMS, (OBSTACLE) DEPARTURE PROCEDURES, AND DIVERSE VECTOR AREA (RADAR VECTORS)

24025

# TAKEOFF MINIMUMS, (OBSTACLE) DEPARTURE PROCEDURES, AND DIVERSE VECTOR AREA (RADAR VECTORS)

24025

## SIDNEY, OH

### SIDNEY MUNI (SCA)

#### TAKEOFF MINIMUMS AND (OBSTACLE) DEPARTURE PROCEDURES

AMDT 3 06FEB14 (14037) (FAA)

##### TAKEOFF OBSTACLE NOTES:

- Rwy 5**, trees beginning 1695' from DER, 686' right of centerline, up to 100' AGL/1149' MSL.  
Power poles beginning 2125' from DER, crossing centerline, up to 100' AGL/1149' MSL.  
Trees beginning 3071' from DER, 402' right of centerline, up to 100' AGL/1149' MSL.  
Tree 3247' from DER, 894' left of centerline, 100' AGL/1149' MSL.  
Trees beginning 3723' from DER, 208' left of centerline, up to 100' AGL/1149' MSL.  
**Rwy 10**, terrain beginning 26' from DER, 72' right of centerline, up to 1048' MSL.  
Terrain beginning 36' from DER, 109' left of centerline, up to 1048' MSL.  
Tree 834' from DER, 238' left of centerline, 49' AGL/1100' MSL.  
Trees beginning 1060' from DER, 492' right of centerline, up to 100' AGL/1154' MSL.  
Trees beginning 3577' from DER, 48' right of centerline, up to 90' AGL/1141' MSL.  
**Rwy 23**, vehicles and aircraft on ramp beginning at DER, 138' left of centerline, up to 15' AGL/1054' MSL.  
Trees beginning at DER, 308' left of centerline, up to 100' AGL/1149' MSL.  
Vehicles on road beginning 110' from DER, crossing centerline, up to 15' AGL/1054' MSL.  
Trees beginning 902' from DER, crossing centerline, up to 100' AGL/1149' MSL.  
**Rwy 28**, sign 5' from DER, 56' left of centerline, 2' AGL/1041' MSL.  
Trees beginning 1261' from DER, 405' right of centerline, up to 71' AGL/1102' MSL.  
Trees beginning 1658' from DER, crossing centerline, up to 93' AGL/1114' MSL.

## SOUTH BEND, IN

### SOUTH BEND INTL (SBN)

#### TAKEOFF MINIMUMS AND (OBSTACLE) DEPARTURE PROCEDURES

AMDT 9A 14JUL22 (22195) (FAA)

##### TAKEOFF MINIMUMS:

- Rwy 27R**, 300-1¼ or std. w/min. climb of 240' per NM to 1100. Or alternatively, with std. takeoff minimums and a normal 200' per NM climb gradient, takeoff must occur no later than 1800' prior to DER.

##### DEPARTURE PROCEDURE:

- Rwy 9R**, climb on heading 094° to 2000 before turning south.  
**Rwy 18**, climb on heading 184° to 2000 before turning east.

##### TAKEOFF OBSTACLE NOTES:

- Rwy 9L**, fence 23' from DER, 389' left of centerline, 10' AGL/792' MSL.  
Trees beginning 29' from DER, 465' left of centerline, up to 36' AGL/820' MSL.  
Trees, transmission lines, electrical system beginning 105' from DER, 8' left of centerline, up to 846' MSL.  
Trees beginning 1218' from DER, 45' right of centerline, up to 817' MSL.  
Tree 1244' from DER, 684' right of centerline, 829' MSL.  
Trees beginning 1258' from DER, 66' right of centerline, up to 832' MSL.  
Trees beginning 1313' from DER, 92' right of centerline, up to 842' MSL.  
Trees beginning 1333' from DER, 65' right of centerline, up to 846' MSL.  
Transmission line 3600' from DER, 385' left of centerline, 110' AGL/876' MSL.  
**Rwy 9R**, trees beginning 1727' from DER, 587' left of centerline, up to 816' MSL.  
Tree 1756' from DER, 818' left of centerline, 822' MSL.  
**Rwy 18**, terrain 11' from DER, 253' right of centerline, 761' MSL.  
Fence, terrain beginning 25' from DER, 348' right of centerline, up to 11' AGL/773' MSL.  
Tree, vehicles on road beginning 148' from DER, 415' left of centerline, up to 784' MSL.  
Trees, poles beginning 755' from DER, 561' left of centerline, up to 66' AGL/825' MSL.  
Pole 842' from DER, 518' right of centerline, 27' AGL/783' MSL.  
Trees beginning 1009' from DER, 15' right of centerline, up to 840' MSL.  
Trees beginning 1564' from DER, 12' left of centerline, up to 91' AGL/849' MSL.  
Trees beginning 2434' from DER, 128' right of centerline, up to 848' MSL.  
Trees beginning 2530' from DER, 34' right of centerline, up to 849' MSL.  
Trees beginning 2553' from DER, 125' right of centerline, up to 852' MSL.  
Trees beginning 2815' from DER, 261' left of centerline, up to 851' MSL.  
**Rwy 27L**, pole 667' from DER, 480' left of centerline, 23' AGL/810' MSL.  
Tree 1178' from DER, 615' left of centerline, 861' MSL.  
Trees, poles beginning 1184' from DER, 56' left of centerline, up to 875' MSL.  
Tree 1215' from DER, 665' right of centerline, 28' AGL/827' MSL.  
Trees, vehicles on roads, poles beginning 1485' from DER, 23' left of centerline, up to 888' MSL.  
Pole 1647' from DER, 49' right of centerline, 27' AGL/832' MSL.  
Tree 1750' from DER, 653' right of centerline, 33' AGL/835' MSL.  
Trees beginning 1965' from DER, 18' left of centerline, up to 895' MSL.  
Trees beginning 2336' from DER, 125' left of centerline, up to 898' MSL.  
Tree 3478' from DER, 213' right of centerline, 877' MSL.  
Trees beginning 3512' from DER, 70' right of centerline, up to 888' MSL.  
Trees beginning 3611' from DER, 261' left of centerline, up to 900' MSL.  
Trees beginning 3768' from DER, 83' right of centerline, up to 905' MSL.  
Trees beginning 4238' from DER, 102' right of centerline, up to 914' MSL.  
Tree 4748' from DER, 538' left of centerline, 97' AGL/913' MSL.  
Tree 4766' from DER, 240' right of centerline, 919' MSL.  
Trees beginning 4809' from DER, 265' right of centerline, up to 926' MSL.  
Trees beginning 4942' from DER, 479' right of centerline, up to 927' MSL.

CONT

# TAKEOFF MINIMUMS, (OBSTACLE) DEPARTURE PROCEDURES, AND DIVERSE VECTOR AREA (RADAR VECTORS)

24025

# TAKEOFF MINIMUMS, (OBSTACLE) DEPARTURE PROCEDURES, AND DIVERSE VECTOR AREA (RADAR VECTORS)

24025

## SOUTH BEND, IN (CON'T)

### SOUTH BEND INTL (SBN) (CON'T)

**Rwy 27L (CON'T)**, tree 5442' from DER, 658' right of centerline, 935' MSL.

**Rwy 27R**, tree 66' from DER, 497' right of centerline, 843' MSL.

Tree 137' from DER, 507' right of centerline, 846' MSL.

Trees beginning 206' from DER, 501' right of centerline, up to 79' AGL/849' MSL.

Tree 589' from DER, 579' left of centerline, 803' MSL.

Trees beginning 676' from DER, 10' right of centerline, up to 857' MSL.

Trees beginning 808' from DER, 27' left of centerline, up to 843' MSL.

Trees beginning 1161' from DER, 10' left of centerline, up to 844' MSL.

Trees beginning 1247' from DER, 18' left of centerline, up to 853' MSL.

Trees beginning 1374' from DER, 32' left of centerline, up to 857' MSL.

Trees beginning 1518' from DER, 51' left of centerline, up to 859' MSL.

Trees beginning 1723' from DER, 0' right of centerline, up to 863' MSL.

Trees beginning 1789' from DER, 33' left of centerline, up to 866' MSL.

Trees beginning 2321' from DER, 39' right of centerline, up to 885' MSL.

Trees beginning 2468' from DER, 288' left of centerline, up to 880' MSL.

Trees beginning 3256' from DER, 1138' left of centerline, up to 892' MSL.

Tree 3652' from DER, 1213' right of centerline, 886' MSL.

Tree 4922' from DER, 1742' right of centerline, 913' MSL.

Transmission line 5541' from DER, 1924' right of centerline, 99' AGL/954' MSL.

Tree 5611' from DER, 2003' right of centerline, 941' MSL.

**Rwy 36**, terrain beginning 58' from DER, 349' left of centerline, up to 801' MSL.

Terrain 97' from DER, 390' left of centerline, 803' MSL.

General utility 123' from DER, 415' left of centerline, 6' AGL/808' MSL.

Tree 1693' from DER, 13' left of centerline, 842' MSL.

Tree 1817' from DER, 15' left of centerline, 844' MSL.

Trees beginning 1835' from DER, 837' right of centerline, up to 850' MSL.

Tree 1953' from DER, 873' right of centerline, 857' MSL.

Tree 1953' from DER, 9' left of centerline, 848' MSL.

Tree 2065' from DER, 6' left of centerline, 852' MSL.

Trees beginning 2068' from DER, 848' right of centerline, up to 865' MSL.

Trees beginning 2338' from DER, 442' left of centerline, up to 868' MSL.

## SPRINGFIELD, OH

### SPRINGFIELD/BECKLEY MUNI (SGH)

#### TAKEOFF MINIMUMS AND (OBSTACLE) DEPARTURE PROCEDURES

ORIG 05JUN08 (21336) (FAA)

#### TAKEOFF OBSTACLE NOTES:

**Rwy 6**, trees beginning 642' from DER, 664' left of centerline, up to 96' AGL/1133' MSL.

Tree 66' from DER, 514' right of centerline, 27' AGL/1064' MSL.

**Rwy 15**, multiple trees beginning 1357' from DER, 160' left of centerline, up to 86' AGL/1127' MSL.

Tree 1763' from DER, 410' right of centerline, 51' AGL/1092' MSL.

**Rwy 24**, trees beginning 1387' from DER, 66' left of centerline, up to 58' AGL/1109' MSL.

Windssock 1' from DER, 228' right of centerline, 20' AGL/1071' MSL.

**Rwy 33**, tree 183' from DER, 438' right of centerline, 24' AGL/1066' MSL.

## STEBENVILLE, OH

### GEARY A BATES/JEFFERSON COUNTY AIRPARK (2G2)

#### TAKEOFF MINIMUMS AND (OBSTACLE) DEPARTURE PROCEDURES

AMDT 2 10NOV16 (22083) (FAA)

#### TAKEOFF MINIMUMS:

**Rwy 32**, 300-1 $\frac{1}{4}$  or std. w/min. climb of 280' per NM to 1600.

#### DEPARTURE PROCEDURE:

**Rwy 14**, climb on heading 142° to 2100 before turning left.

#### TAKEOFF OBSTACLE NOTES:

**Rwy 14**, tree 32' from DER, 500' right of centerline, 73' AGL/1240' MSL.

Tree 58' from DER, 448' right of centerline, 71' AGL/1245' MSL.

Trees beginning 113' from DER, 329' left of centerline, up to 43' AGL/1207' MSL.

Trees, beginning 162' from DER, 210' right of centerline, up to 74' AGL/1251' MSL.

Trees, beginning 196' from DER, 186' left of centerline, up to 60' AGL/1208' MSL.

Trees, beginning 221' from DER, 184' left of centerline, up to 54' AGL/1209' MSL.

Trees, beginning 240' from DER, 24' right of centerline, up to 96' AGL/1258' MSL.

Tree 376' from DER, 513' left of centerline, 96' AGL/1235' MSL.

**Rwy 32**, tree, bush, beginning 0' from DER, 334' left of centerline, up to 59' AGL/1244' MSL.

Tree, ground, bush, beginning 113' from DER, 392' left of centerline, up to 67' AGL/1246' MSL.

Ant 1.3 NM from DER, 760' left of centerline, 193' AGL/1405' MSL.

Tower 1.3 NM from DER, 764' left of centerline, 199' AGL/1411' MSL.

# TAKEOFF MINIMUMS, (OBSTACLE) DEPARTURE PROCEDURES, AND DIVERSE VECTOR AREA (RADAR VECTORS)

24025

EC-2

# TAKEOFF MINIMUMS, (OBSTACLE) DEPARTURE PROCEDURES, AND DIVERSE VECTOR AREA (RADAR VECTORS)

24025

## SULLIVAN, IN

### SULLIVAN COUNTY (SIV)

#### TAKEOFF MINIMUMS AND (OBSTACLE) DEPARTURE PROCEDURES

AMDT 1 30DEC99 (99364) (FAA)

##### TAKEOFF MINIMUMS:

**Rwys 18, 36**, 200-1 or std. with a min. climb of 320' per NM to 1800.

##### DEPARTURE PROCEDURE:

**Rwy 18**, climb runway heading to 1500 before turning west on course.

**Rwys 18,36**, climb runway heading to 1800 before turning east on course.

## TELL CITY, IN

### PERRY COUNTY MUNI (TEL)

#### TAKEOFF MINIMUMS AND (OBSTACLE) DEPARTURE PROCEDURES

AMDT 2 25AUG11 (21112) (FAA)

##### TAKEOFF OBSTACLE NOTES:

**Rwy 13**, fence, terrain, buildings, and trees beginning 6' from DER, 131' left of centerline, up to 49' AGL/ 740' MSL.  
Terrain, trees, and poles beginning 93' from DER, 19' right of centerline, up to 30' AGL/750' MSL.

**Rwy 31**, trees, terrain, and pole beginning 125' from DER, 141' left of centerline, up to 25' AGL/702' MSL.  
Trees, terrain, and tower beginning 68' from DER, 64' right of centerline, up to 56' AGL/ 648' MSL.

## TERRE HAUTE, IN

### SKY KING (313)

#### TAKEOFF MINIMUMS AND (OBSTACLE) DEPARTURE PROCEDURES

AMDT 5A 11AUG22 (22223) (FAA)

##### TAKEOFF MINIMUMS:

**Rwys 18, 36**, NA-Environmental.

##### DEPARTURE PROCEDURE:

**Rwy 27**, climb heading 268° to 1300 before turning left.

##### TAKEOFF OBSTACLE NOTES:

**Rwy 9**, multiple power lines beginning 34' from DER, left and right of centerline, up to 30' AGL/529' MSL.  
Vehicle on road beginning 54' from DER, left and right of centerline, up to 15' AGL/519' MSL.

Fence beginning 33' from DER, left and right of centerline, up to 6' AGL/505' MSL.

Multiple buildings beginning 167' from DER, left and right of centerline, up to 60' AGL/589' MSL.

**Rwy 27**, trees beginning abeam DER, 235' right of centerline, up to 60' AGL/559' MSL.

Trees beginning abeam DER, 382' left of centerline, up to 60' AGL/539' MSL.

Trees beginning 1057' from DER, 47' left of centerline, up to 60' AGL/539' MSL.

## TERRE HAUTE RGNL (HUF)

#### TAKEOFF MINIMUMS AND (OBSTACLE) DEPARTURE PROCEDURES

ORIG-A 26APR18 (18116) (FAA)

##### TAKEOFF OBSTACLE NOTES:

**Rwy 5**, terrain beginning 118' from DER, left and right of centerline, 0' AGL/591' MSL.

Floodlight 967' from DER, 673' right of centerline, 32' AGL/621' MSL.

Trees beginning 2019' from DER, 317' left of centerline, up to 100' AGL/689' MSL.

Tree 3340' from DER, 533' right of centerline, 79' AGL/668' MSL.

**Rwy 14**, trees beginning 1266' from DER, 570' left of centerline, up to 100' AGL/689' MSL.

Trees beginning 1,520' from DER 462' right of centerline, up to 100' AGL/689' MSL.

Power lines 3084' from DER, left and right of centerline, 98' AGL/682' MSL.

**Rwy 23**, trees beginning 412' from DER, 537' left of centerline, up to 34' AGL/593' MSL.

Tree 1201' from DER, 376' right of centerline, 38' AGL/607' MSL.

**Rwy 32**, trees and a pole beginning 397' from DER, 308' left of centerline, up to 82' AGL/651' MSL.

Tree 1195' from DER 544' left of centerline, 68' AGL/637' MSL.

Trees beginning 2597' from DER, 340' right of centerline, up to 100' AGL/669' MSL.

## TIFFIN, OH

### SENECA COUNTY(16G)

#### TAKEOFF MINIMUMS AND (OBSTACLE) DEPARTURE PROCEDURES

AMDT 2 02JUL09 (09183) (FAA)

##### TAKEOFF OBSTACLE NOTES:

**Rwy 6**, multiple trees and buildings beginning 2' from DER, 186' right of centerline, up to 98' AGL/868' MSL.

Antenna 129' from DER, 438' left of centerline, 66' AGL/836' MSL.

Pole 408' from DER, 477' left of centerline, 39' AGL/809' MSL.

Vehicle on road 501' from DER, 414' left of centerline, 26' AGL/796' MSL.

Trees 2421' from DER, 207' left of centerline, 83' AGL/853' MSL.

**Rwy 24**, multiple trees beginning 27' from DER, 280' left of centerline, up to 124' AGL/904' MSL.

Building 1291' from DER, 528' left of centerline, 44' AGL/824' MSL.

Multiple trees beginning 1071' from DER, 337' right of centerline, up to 92' AGL/872' MSL.

Pole 1460' from DER, 562' right of centerline, 48' AGL/828' MSL.

# TAKEOFF MINIMUMS, (OBSTACLE) DEPARTURE PROCEDURES, AND DIVERSE VECTOR AREA (RADAR VECTORS)

24025

EC-2

# TAKEOFF MINIMUMS, (OBSTACLE) DEPARTURE PROCEDURES, AND DIVERSE VECTOR AREA (RADAR VECTORS)

24025

## TOLEDO, OH

### EUGENE F KRANZ TOLEDO EXPRESS (TOL)

#### TAKEOFF MINIMUMS AND (OBSTACLE) DEPARTURE PROCEDURES

AMDT 3A 05NOV20 (20310) (FAA)

##### TAKEOFF OBSTACLE NOTES:

**Rwy 7**, vehicles on road beginning 246' from DER, 525' right of centerline, up to 10' AGL/671' MSL.

Tree 1339' from DER, 667' left of centerline, 700' MSL.

Trees beginning 1903' from DER, 799' right of centerline, up to 741' MSL.

Tree 2392' from DER, 852' left of centerline, 734' MSL.

Tree 2604' from DER, 1047' left of centerline, 756' MSL.

**Rwy 16**, terrain 59' from DER, 496' left of centerline, 671' MSL.

Tree 618' from DER, 659' right of centerline, 739' MSL.

Trees beginning 719' from DER, 42' right of centerline, up to 752' MSL.

Tree 985' from DER, 478' left of centerline, 694' MSL.

Tree 1021' from DER, 518' left of centerline, 714' MSL.

Tree 1043' from DER, 571' left of centerline, 730' MSL.

Tree 1139' from DER, 711' left of centerline, 732' MSL.

Tree 1279' from DER, 806' left of centerline, 745' MSL.

Tree 1318' from DER, 689' left of centerline, 753' MSL.

Trees beginning 1388' from DER, 648' left of centerline, up to 757' MSL.

Trees beginning 1491' from DER, 80' left of centerline, up to 758' MSL.

Trees beginning 2607' from DER, 155' right of centerline, up to 765' MSL.

Trees beginning 2704' from DER, 36' right of centerline, up to 767' MSL.

Trees beginning 3029' from DER, 45' right of centerline, up to 786' MSL.

**Rwy 25**, vegetation 245' from DER, 473' right of centerline, 692' MSL.

Vegetation 485' from DER, 527' right of centerline, 695' MSL.

Tree 2214' from DER, 870' right of centerline, 746' MSL.

Tree 2362' from DER, 907' left of centerline, 780' MSL.

**Rwy 34**, vehicles on road beginning 247' from DER, 488' left of centerline, up to 10' AGL/689' MSL.

Pole, vehicles on road beginning 445' from DER, 533' left of centerline, up to 38' AGL/713' MSL.

Vehicles on road beginning 574' from DER, 622' right of centerline, up to 10' AGL/689' MSL.

Pole 632' from DER, 539' left of centerline, 38' AGL/714' MSL.

Poles, tree beginning 704' from DER, 522' left of centerline, up to 38' AGL/715' MSL.

Trees, pole beginning 1036' from DER, 411' left of centerline, up to 718' MSL.

Trees beginning 1272' from DER, 156' left of centerline, up to 752' MSL.

Pole 1287' from DER, 699' right of centerline, 36' AGL/711' MSL.

Trees beginning 1826' from DER, 102' right of centerline, up to 760' MSL.

Trees beginning 2489' from DER, 90' left of centerline, up to 761' MSL.

Trees, tower, grain elevator beginning 2726' from DER, 92' left of centerline, up to 780' MSL.

Tree 2912' from DER, 119' right of centerline, 766' MSL.

Trees beginning 2953' from DER, 451' right of centerline, up to 780' MSL.

## TOLEDO EXEC (TDZ)

#### TAKEOFF MINIMUMS AND (OBSTACLE) DEPARTURE PROCEDURES

AMDT 3 21MAY20 (21280) (FAA)

##### TAKEOFF MINIMUMS:

**Rwy 4**, std. w/min. climb of 230' per NM to 2500, or 1300-2½ for VCOA.

##### DEPARTURE PROCEDURE:

**Rwy 4**, climb on heading 046° to 2100 before turning left.

**Rwy 32**, climb on heading 321° to 1400 before turning right.

##### VCOA:

**Rwy 4**, obtain ATC approval for VCOA when requesting IFR clearance. Climb in visual conditions to cross Toledo Exec airport at or above 1800 before proceeding on course.

##### TAKEOFF OBSTACLE NOTES:

**Rwy 4**, electrical system 10' from DER, 26' left of centerline, 3' AGL/621' MSL.

Sign 22' from DER, 168' right of centerline, 3' AGL/622' MSL.

Vehicle on road, pole beginning 284' from DER, 186' right of centerline, up to 646' MSL.

Tree, pole, vehicle on road beginning 372' from DER, 95' right of centerline, up to 655' MSL.

Trees, vehicle on road beginning 403' from DER, 1' right of centerline, up to 660' MSL.

Vehicle on road 489' from DER, 164' left of centerline, 647' MSL.

Trees, vehicle on road beginning 558' from DER, 1' left of centerline, up to 651' MSL.

Trees beginning 639' from DER, 437' right of centerline, up to 679' MSL.

Trees beginning 785' from DER, 412' right of centerline, up to 681' MSL.

Trees, pole beginning 1096' from DER, 162' right of centerline, up to 694' MSL.

Trees beginning 1996' from DER, 50' left of centerline, up to 680' MSL.

Towers beginning 3309' from DER, 1030' left of centerline, up to 761' MSL.

**Rwy 14**, sign 23' from DER, 248' left of centerline, 3' AGL/622' MSL.

Sign 39' from DER, 467' left of centerline, 4' AGL/623' MSL.

Vehicle on road beginning 137' from DER, 283' right of centerline, up to 638' MSL.

Vehicle on road, signs, pole beginning 169' from DER, 168' left of centerline, up to 15' AGL/638' MSL.

Vehicle on road, poles beginning 478' from DER, 84' left of centerline, up to 639' MSL.

Vehicle on road beginning 487' from DER, 155' right of centerline, up to 639' MSL.

Poles beginning 573' from DER, 143' left of centerline, up to 20' AGL/640' MSL.

Poles beginning 629' from DER, 384' left of centerline, up to 20' AGL/641' MSL.

CON'T

# TAKEOFF MINIMUMS, (OBSTACLE) DEPARTURE PROCEDURES, AND DIVERSE VECTOR AREA (RADAR VECTORS)

24025

EC-2



**TAKEOFF MINIMUMS, (OBSTACLE) DEPARTURE PROCEDURES, AND  
DIVERSE VECTOR AREA (RADAR VECTORS)**

24025

**TOLEDO, OH (CON'T)****TOLEDO EXEC (TDZ) (CON'T)****Rwy 14 (CON'T)**, pole 685' from DER, 585' left of centerline, 32' AGL/652' MSL.

Poles, buildings beginning 694' from DER, 428' left of centerline, up to 35' AGL/654' MSL.

Sign 739' from DER, 6' right of centerline, 22' AGL/644' MSL.

Building 996' from DER, 672' left of centerline, 657' MSL.

Poles, building beginning 1043' from DER, 305' left of centerline, up to 45' AGL/664' MSL.

Pole beginning 1285' from DER, 565' left of centerline, up to 47' AGL/667' MSL.

Pole 1419' from DER, 252' right of centerline, 38' AGL/658' MSL.

Pole 1487' from DER, 328' right of centerline, 40' AGL/661' MSL.

Trees beginning 1712' from DER, 72' left of centerline, up to 689' MSL.

**Rwy 22**, electrical system 10' from DER, 26' left of centerline, 2' AGL/623' MSL.

Electrical system 45' from DER, 299' left of centerline, 4' AGL/624' MSL.

Fence 112' from DER, 311' left of centerline, 7' AGL/627' MSL.

Fence 207' from DER, 298' left of centerline, 9' AGL/629' MSL.

Pole 251' from DER, 467' left of centerline, 35' AGL/655' MSL.

Poles, vehicle on road, tree beginning 251' from DER, 108' left of centerline, up to 40' AGL/660' MSL.

Vehicle on road 568' from DER, 2' right of centerline, 637' MSL.

Poles, transmission line, vehicle on road, tree beginning 582' from DER, 246' right of centerline, up to 48' AGL/671' MSL.

Trees, vehicle on road, sign, poles, transmission lines, fence, bridge beginning 595' from DER, 23' left of centerline, up to 684' MSL.

Tower, transmission line beginning 797' from DER, 307' right of centerline, up to 101' AGL/726' MSL.

Tower, vehicle on road, poles, trees, transmission line beginning 807' from DER, 32' right of centerline, up to 98' AGL/727' MSL.

Tree 2062' from DER, 524' left of centerline, 685' MSL.

Trees beginning 2130' from DER, 589' left of centerline, up to 692' MSL.

Tree 2534' from DER, 1053' left of centerline, 75' AGL/697' MSL.

**Rwy 32**, fence beginning 43' from DER, 424' left of centerline, up to 7' AGL/626' MSL.

Tree 177' from DER, 521' left of centerline, 648' MSL.

Tree, poles, vehicle on road beginning 242' from DER, 346' left of centerline, up to 662' MSL.

Poles, vehicle on road, trees beginning 556' from DER, 18' left of centerline, up to 40' AGL/681' MSL.

Tree 683' from DER, 373' right of centerline, 640' MSL.

Pole 1042' from DER, 79' right of centerline, 659' MSL.

Transmission line 1092' from DER, 193' right of centerline, 46' AGL/665' MSL.

Pole 1206' from DER, 29' right of centerline, 43' AGL/666' MSL.

Transmission line, poles beginning 1271' from DER, 62' right of centerline, up to 55' AGL/674' MSL.

Transmission lines 1605' from DER, 559' right of centerline, 61' AGL/680' MSL.

Transmission line 1676' from DER, 559' right of centerline, 61' AGL/682' MSL.

Pole, transmission line beginning 1679' from DER, 559' right of centerline, up to 71' AGL/691' MSL.

Poles, transmission lines beginning 1781' from DER, 639' right of centerline, up to 74' AGL/692' MSL.

Trees beginning 1998' from DER, 144' left of centerline, up to 693' MSL.

Pole, tower beginning 2903' from DER, 1189' right of centerline, up to 716' MSL.

Transmission line 3372' from DER, 478' right of centerline, 139' AGL/755' MSL.

**UPPER SANDUSKY, OH****WYANDOT COUNTY (56D)****TAKEOFF MINIMUMS AND (OBSTACLE) DEPARTURE PROCEDURES**

ORIG 15MAY80 (80150) (FAA)

TAKEOFF MINIMUMS:

**Rwy 36**, 300-1.**URBANA, OH****GRIMES FLD (I74)****TAKEOFF MINIMUMS AND (OBSTACLE) DEPARTURE PROCEDURES**

AMDT 1A 03NOV22 (22307) (FAA)

TAKEOFF MINIMUMS:

**Rwys 1, 19**, NA-Environmental.

TAKEOFF OBSTACLE NOTES:

**Rwy 2**, numerous trees beginning 995' from DER, 6' left of centerline, up to 100' AGL/1152' MSL.

Numerous trees beginning from 2106' from DER, 327' right of centerline, up to 100' AGL/1140' MSL.

Numerous power poles 1204' from DER, 654' right of centerline, 55' AGL/1125' MSL.

**Rwy 20**, numerous trees beginning 5' from DER, 487' left of centerline, up to 100' AGL/1111' MSL.

Tank 5459' from DER, 1062' left of centerline, 170' AGL/1195' MSL.

Numerous trees beginning 672' from DER, 92' right of centerline, up to 100' AGL/1120' MSL.

22 FEB 2024 to 21 MAR 2024

22 FEB 2024 to 21 MAR 2024

**TAKEOFF MINIMUMS, (OBSTACLE) DEPARTURE PROCEDURES, AND  
DIVERSE VECTOR AREA (RADAR VECTORS)**

24025

# TAKEOFF MINIMUMS, (OBSTACLE) DEPARTURE PROCEDURES, AND DIVERSE VECTOR AREA (RADAR VECTORS)

24025

## VALPARAISO, IN

### PORTER COUNTY RGNL (VPZ)

#### TAKEOFF MINIMUMS AND (OBSTACLE) DEPARTURE PROCEDURES

ORIG 14FEB08 (08045) (FAA)

#### TAKEOFF OBSTACLE NOTES:

**Rwy 9**, tree 51' from DER, 350' right of centerline, 100' AGL/874' MSL.

Tree 1219' from DER, 775' left of centerline, 57' AGL/807' MSL.

**Rwy 18**, tower and multiple trees beginning 140' from DER, 157' right of centerline, up to 100' AGL/865' MSL.

Trees 143' from DER, 71' left of centerline, 100' AGL/865' MSL.

**Rwy 27**, multiple trees, 1038' from DER, 308' left of centerline, up to 68' AGL/828' MSL.

Sign, 1847' from DER, 263' right of centerline, 49' AGL/817' MSL.

**Rwy 36**, trees 105' from DER, 99' right of centerline, 100' AGL/895' MSL

Trees 108' from DER, 129' left of centerline, 100' AGL/874' MSL.

## VAN WERT, OH

### VAN WERT COUNTY (VNW)

#### TAKEOFF MINIMUMS AND (OBSTACLE) DEPARTURE PROCEDURES

AMDT 3 15JAN09 (09015) (FAA)

#### TAKEOFF MINIMUMS:

**Rwy 9**, 300-1¼ or std. w/ min. climb of 306' per NM to 1100.

**Rwys 18, 36**, NA-Environmental.

#### TAKEOFF OBSTACLE NOTES:

**Rwy 9**, tower 6084' from DER, 1963' left of centerline, 170' AGL/955' MSL.

## VERSAILLES, OH

### DARKE COUNTY (VES)

#### TAKEOFF MINIMUMS AND (OBSTACLE) DEPARTURE PROCEDURES

AMDT 3 08NOV18 (18312) (FAA)

#### TAKEOFF OBSTACLE NOTES:

**Rwy 9**, pole 20' from DER, 83' left of centerline, 1006' MSL.

Pole 20' from DER, 81' right of centerline, 1005' MSL.

Tree, antenna, pole, buildings beginning 169' from DER, 357' left of centerline, up to 44' AGL/1045' MSL.

Tree, vehicles on road, buildings beginning 237' from DER, 131' left of centerline, up to 1053' MSL.

Tree, vehicles on road beginning 366' from DER, 15' left of centerline, up to 1072' MSL.

Vehicles on road beginning 410' from DER, left and right of centerline, up to 1017' MSL.

Trees beginning 835' from DER, 688' right of centerline, up to 1086' MSL.

Tree 1066' from DER, 696' right of centerline, 1095' MSL.

Trees beginning 1149' from DER, 472' right of centerline, up to 1101' MSL.

Trees beginning 1341' from DER, 295' right of centerline, up to 1108' MSL.

Trees beginning 1445' from DER, 235' right of centerline, up to 1112' MSL.

**Rwy 27**, pole 121' from DER, 356' left of centerline, 1028' MSL.

Pole, tree beginning 121' from DER, 447' right of centerline, up to 1037' MSL.

Trees beginning 982' from DER, 503' right of centerline, up to 1043' MSL.

Tree 1404' from DER, 162' left of centerline, 1052' MSL.

Tree 1461' from DER, 64' right of centerline, 1051' MSL.

Trees beginning 1722' from DER, 328' left of centerline, up to 1065' MSL.

Tree 1923' from DER, 353' left of centerline, 1067' MSL.

Trees beginning 2062' from DER, 741' left of centerline, up to 1076' MSL.

## WABASH, IN

### WABASH MUNI (IWH)

#### TAKEOFF MINIMUMS AND (OBSTACLE) DEPARTURE PROCEDURES

ORIG 10DEC15 (15344) (FAA)

#### TAKEOFF OBSTACLE NOTES:

**Rwy 9**, trees beginning 194' from DER, left and right of centerline, up to 110' AGL/910' MSL.

**Rwy 18**, trees beginning 310' from DER, 128' left of centerline, up to 83' AGL/873' MSL.

**Rwy 27**, poles and power line beginning 484' from DER, left and right of centerline, up to 44' AGL/840' MSL.

Vehicles on road beginning 502' from DER, left and right of centerline, up to 15' AGL/813' MSL.

Tree 517' from DER, 618' left of centerline, 77' AGL/871' MSL.

Trees beginning 624' from DER, left and right of centerline, up to 64' AGL/855' MSL.

Poles and power line beginning 1613' from DER, left and right of centerline, up to 48' AGL/853' MSL.

**Rwy 36**, buildings beginning 31' from DER, 272' left of centerline, up to 25' AGL/815' MSL.

Trees beginning 459' from DER, left and right of centerline, up to 70' AGL/876' MSL.

Vehicles on road 469' from DER, left and right of centerline, up to 15' AGL/804' MSL.

# TAKEOFF MINIMUMS, (OBSTACLE) DEPARTURE PROCEDURES, AND DIVERSE VECTOR AREA (RADAR VECTORS)

24025

# TAKEOFF MINIMUMS, (OBSTACLE) DEPARTURE PROCEDURES, AND DIVERSE VECTOR AREA (RADAR VECTORS)

24025

## WADSWORTH, OH

### WADSWORTH MUNI (3G3)

#### TAKEOFF MINIMUMS AND (OBSTACLE) DEPARTURE PROCEDURES

AMDT 2 08NOV18 (18312) (FAA)

#### TAKEOFF MINIMUMS:

**Rwy 2**, 400-2¼ w/min. climb of 280' per NM to 1900 or std. w/min. climb of 445' per NM to 1500 or 1100-3 for VCOA.

**Rwy 10**, 700-3 or std. w/min. climb of 760' per NM to 1500.

**Rwy 20**, 300-1½ or std. w/min. climb of 380' per NM to 1300.

**Rwy 28**, 400-2¼ or std. w/min. climb of 475' per NM to 1400.

#### DEPARTURE PROCEDURE:

**Rwy 10**, climb heading 097° to 1700 before proceeding on course.

**Rwy 28**, climb heading 277° to 1500 before turning right.

#### VCOA:

**Rwy 2**, obtain ATC approval for VCOA when requesting IFR clearance. Climb in visual conditions to cross Wadsworth Muni Airport at or above 1900 before proceeding on course.

#### TAKEOFF OBSTACLE NOTES:

**Rwy 2**, fence 9' from DER, 268' right of centerline, up to 6' AGL/979' MSL.

Vehicles on road beginning 90' from DER, 368' right of centerline, up to 1001' MSL.

Tree 98' from DER, 197' left of centerline, 1011' MSL.

Trees, vehicles on road, building, power poles beginning 393' from DER, 193' right of centerline, up to 100' AGL/1079' MSL.

Tree, power poles beginning 1220' from DER, 342' left of centerline, up to 100' AGL/1079' MSL.

Tree 1626' from DER, 915' right of centerline, 100' AGL/1109' MSL.

Tree 1852' from DER, 986' right of centerline, 100' AGL/1119' MSL.

Tree 2796' from DER, 1245' right of centerline, 100' AGL/1129' MSL.

Tree 3167' from DER, 1337' right of centerline, 100' AGL/1139' MSL.

Tree 3461' from DER, 1401' right of centerline, 100' AGL/1149' MSL.

Tree 3800' from DER, 1488' right of centerline, 100' AGL/1159' MSL.

Tree 4451' from DER, 1684' right of centerline, 100' AGL/1169' MSL.

Trees beginning 4895' from DER, 1351' right of centerline, up to 100' AGL/1179' MSL.

Tree 5592' from DER, 1977' right of centerline, 100' AGL/1189' MSL.

Tree 5763' from DER, 2016' right of centerline, 100' AGL/1199' MSL.

Trees beginning 5999' from DER, 1592' right of centerline, up to 100' AGL/1209' MSL.

Tree 1.1 NM from DER, 2323' right of centerline, 100' AGL/1219' MSL.

Tree 1.1 NM from DER, 2363' right of centerline, 100' AGL/1229' MSL.

Tree 1.1 NM from DER, 2384' right of centerline, 100' AGL/1239' MSL.

Tree 1.2 NM from DER, 2540' right of centerline, 100' AGL/1249' MSL.

Tree 1.4 NM from DER, 2776' right of centerline, 100' AGL/1259' MSL.

Tree 1.4 NM from DER, 545' left of centerline, 100' AGL/1259' MSL.

Tree 1.4 NM from DER, 2911' right of centerline, 100' AGL/1269' MSL.

Tree 1.5 NM from DER, 2963' right of centerline, 100' AGL/1279' MSL.

Tree 1.5 NM from DER, 614' left of centerline, 100' AGL/1289' MSL.

Tree 1.6 NM from DER, 1988' left of centerline, 100' AGL/1279' MSL.

Tower, tree, tank beginning 1.6 NM from DER, 2010' left of centerline, up to 211' AGL/1368' MSL.

Tree 1.7 NM from DER, 3304' right of centerline, 100' AGL/1289' MSL.

Tree 1.8 NM from DER, 2997' right of centerline, 100' AGL/1299' MSL.

Tree beginning 1.9 NM from DER, 3077' right of centerline, up to 100' AGL/1309' MSL.

Tree 2.4 NM from DER, 4211' right of centerline, 100' AGL/1379' MSL.

**Rwy 10**, trees beginning 197' from DER, 284' right of centerline, up to 991' MSL.

Tree 254' from DER, 489' right of centerline, 993' MSL.

Trees, vehicles on road beginning 298' from DER, 366' right of centerline, up to 996' MSL.

Trees, vehicles on road beginning 412' from DER, 114' right of centerline, up to 100' AGL/1089' MSL.

Vehicles on road 421' from DER, 445' left of centerline, 1000' MSL.

Vehicles on road beginning 428' from DER, 2' left of centerline, up to 1001' MSL.

Tree 866' from DER, 53' left of centerline, 100' AGL/1087' MSL.

Tree 905' from DER, 719' right of centerline, 100' AGL/1099' MSL.

Tree 1161' from DER, 390' left of centerline, 100' AGL/1109' MSL.

Trees beginning 1241' from DER, 718' left of centerline, up to 100' AGL/1119' MSL.

Trees beginning 1253' from DER, 90' right of centerline, up to 100' AGL/1109' MSL.

Trees beginning 1654' from DER, 637' right of centerline, up to 100' AGL/1129' MSL.

Trees beginning 1985' from DER, 628' right of centerline, up to 100' AGL/1139' MSL.

Tree 2355' from DER, 567' right of centerline, 100' AGL/1149' MSL.

Trees beginning 2422' from DER, 869' right of centerline, up to 100' AGL/1169' MSL.

Trees beginning 2516' from DER, 610' right of centerline, up to 100' AGL/1189' MSL.

Trees beginning 3033' from DER, 998' right of centerline, up to 100' AGL/1219' MSL.

Tree 4103' from DER, 1592' right of centerline, 100' AGL/1239' MSL.

Building 5022' from DER, 1164' left of centerline, 31' AGL/1123' MSL.

Tree 1 NM from DER, 1236' left of centerline, 100' AGL/1239' MSL.

Tree 1 NM from DER, 1310' left of centerline, 100' AGL/1249' MSL.

Tree 1 NM from DER, 1494' left of centerline, 100' AGL/1259' MSL.

Tree 1 NM from DER, 1656' left of centerline, 100' AGL/1269' MSL.

Tree 1.1 NM from DER, 1767' left of centerline, 100' AGL/1279' MSL.

Tree 1.1 NM from DER, 1840' left of centerline, 100' AGL/1289' MSL.

Tree 1.1 NM from DER, 1958' left of centerline, 100' AGL/1299' MSL.

Trees beginning 1.1 NM from DER, 2252' left of centerline, up to 100' AGL/1309' MSL.

Trees 1.4 NM from DER, 2522' left of centerline, 100' AGL/1319' MSL.

CON'T

22 FEB 2024 to 21 MAR 2024

22 FEB 2024 to 21 MAR 2024

# TAKEOFF MINIMUMS, (OBSTACLE) DEPARTURE PROCEDURES, AND DIVERSE VECTOR AREA (RADAR VECTORS)

24025

EC-2

# TAKEOFF MINIMUMS, (OBSTACLE) DEPARTURE PROCEDURES, AND DIVERSE VECTOR AREA (RADAR VECTORS)

24025

## WADSWORTH, OH (CON'T)

### WADSWORTH MUNI (3G3) (CON'T)

**Rwy 10 (CON'T)**, tree 1.9 NM from DER, 3653' left of centerline, 100' AGL/1359' MSL.

Tree 2.1 NM from DER, 3881' left of centerline, 100' AGL/1369' MSL.

Tower 2.3 NM from DER, 2131' left of centerline, 416' AGL/1581' MSL.

Tower 2.3 NM from DER, 2131' left of centerline, 416' AGL/1581' MSL.

**Rwy 20**, tree 27' from DER, 216' left of centerline, 991' MSL.

Vehicles on road 28' from DER, 320' right of centerline, 976' MSL.

Trees, vehicles on road, beginning 38' from DER, 303' left of centerline, up to 1034' MSL.

Trees, vehicles on road, beginning 349' from DER, 81' left of centerline, up to 1067' MSL.

Vehicles on road beginning 417' from DER, 22' right of centerline, up to 982' MSL.

Trees, vehicles on road beginning 707' from DER, on and left of centerline, up to 1072' MSL.

Tree 4551' from DER, 156' left of centerline, 1086' MSL.

Tree 4602' from DER, 58' right of centerline, 1092' MSL.

Trees beginning 4627' from DER, 556' left of centerline, 1095' MSL.

Tree 4692' from DER, 478' from centerline, 1101' MSL.

Tree 4709' from DER, 1737' left of centerline, 100' AGL/1179' MSL.

Trees beginning 4767' from DER, 6' left of centerline, up to 100' AGL/1189' MSL.

Tree 1.2 NM from DER, 2431' left of centerline, 100' AGL/1179' MSL.

**Rwy 28**, building 172' from DER, 429' right of centerline, up to 26' AGL/991' MSL.

Tree 1035' from DER, 434' left of centerline, 100' AGL/1069' MSL.

Trees beginning 1265' from DER, 197' left of centerline, up to 100' AGL/1079' MSL.

Tree 3301' from DER, 66' right of centerline, 100' AGL/1089' MSL.

Tree 3401' from DER, 101' right of centerline, 100' AGL/1099' MSL.

Tree 3531' from DER, 108' right of centerline, 100' AGL/1109' MSL.

Tree 3643' from DER, 111' right of centerline, 100' AGL/1119' MSL.

Tree 3746' from DER, 127' right of centerline, 100' AGL/1129' MSL.

Tree 3838' from DER, 162' right of centerline, 100' AGL/1139' MSL.

Tree 3909' from DER, 176' right of centerline, 100' AGL/1149' MSL.

Tree 3987' from DER, 176' right of centerline, 100' AGL/1159' MSL.

Tree 4058' from DER, 211' right of centerline, 100' AGL/1169' MSL.

Tree 4150' from DER, 204' right of centerline, 100' AGL/1179' MSL.

Tree 4185' from DER, 210' right of centerline, 100' AGL/1189' MSL.

Tree 4249' from DER, 224' right of centerline, 100' AGL/1199' MSL.

Trees beginning 4297' from DER, 71' left of centerline, up to 100' AGL/1209' MSL.

Tree 4468' from DER, 125' right of centerline, 100' AGL/1219' MSL.

Tree 4575' from DER, 322' right of centerline, 100' AGL/1229' MSL.

Tree 4780' from DER, 364' right of centerline, 100' AGL/1239' MSL.

Tree 4865' from DER, 335' right of centerline, 100' AGL/1249' MSL.

Trees beginning 5125' from DER, 299' right of centerline, up to 100' AGL/1259' MSL.

Trees beginning 5329' from DER, 797' right of centerline, up to 100' AGL/1269' MSL.

Tree 5693' from DER, 1171' right of centerline, 100' AGL/1279' MSL.

Trees beginning 5693' from DER, 1171' right of centerline, up to 100' AGL/1279' MSL.

Trees beginning 1.5 NM from DER, 974' right of centerline, up to 100' AGL/1299' MSL.

Tree 1.6 NM from DER, 2779' left of centerline, 100' AGL/1269' MSL.

Tree 2.1 NM from DER, 3933' right of centerline, 100' AGL/1299' MSL.

## WAPAKONETA, OH

### NEIL ARMSTRONG (AXV)

#### TAKEOFF MINIMUMS AND (OBSTACLE) DEPARTURE PROCEDURES

AMDT 2 31JUL08 (08213) (FAA)

##### TAKEOFF OBSTACLE NOTES:

**Rwy 8**, vehicle on road, 1' from DER, 403' right of centerline, 15' AGL/926' MSL.

Fence 70' from DER, 222' right of centerline, 6' AGL/919' MSL.

Fence 149' from DER, 270' left of centerline, 8' AGL/921' MSL.

Obstruction light on pole, 348' from DER, 239' left of centerline, 15' AGL/928' MSL.

Building, 614' from DER, 463' left of centerline, 15' AGL/929' MSL.

Trees beginning 2385' from DER, 51' left of centerline, up to 101' AGL/1014' MSL.

Trees beginning 2263' from DER, 268' right of centerline, up to 75' AGL/988' MSL.

**Rwy 26**, obstruction light on DME, 401' from DER, 268' right of centerline, 9' AGL/922' MSL.

Trees beginning 496' from DER, 51' right of centerline, up to 83' AGL/996' MSL.

Trees beginning 563' from DER, 120' left of centerline, up to 72' AGL/985' MSL.

Pole 620' from DER, 332' left of centerline, 25' AGL/938' MSL.

Stack, 3021' from DER, 577' left of centerline, 125' AGL/1035' MSL.

Tower, 3265' from DER, 729' right of centerline, 149' AGL/1050' MSL.

22 FEB 2024 to 21 MAR 2024

22 FEB 2024 to 21 MAR 2024

# TAKEOFF MINIMUMS, (OBSTACLE) DEPARTURE PROCEDURES, AND DIVERSE VECTOR AREA (RADAR VECTORS)

24025

EC-2

**TAKEOFF MINIMUMS, (OBSTACLE) DEPARTURE PROCEDURES, AND  
DIVERSE VECTOR AREA (RADAR VECTORS)**

24025

**WARSAW, IN****WARSAW MUNI (ASW)****TAKEOFF MINIMUMS AND (OBSTACLE) DEPARTURE PROCEDURES**

AMDT 3 30JAN20 (20030) (FAA)

**TAKEOFF MINIMUMS:**

**Rwy 9**, 300-1¼ or std. w/min. climb of 266' per NM to 1100, or alternatively, with std. takeoff minimums and a normal 200' per NM climb gradient, takeoff must occur no later than 2000' prior to DER.

**TAKEOFF OBSTACLE NOTES:**

**Rwy 9**, fence beginning 148' from DER, 476' left of centerline, up to 5' AGL/856' MSL.

Vehicle on road beginning 181' from DER, 22' right of centerline, up to 865' MSL.

Vehicle on road 183' from DER, 264' left of centerline, 865' MSL.

Vehicle on road beginning 184' from DER, 404' left of centerline, up to 866' MSL.

Trees beginning 835' from DER, 447' right of centerline, up to 65' AGL/914' MSL.

Trees beginning 1258' from DER, 755' left of centerline, up to 50' AGL/888' MSL.

Tree 1283' from DER, 763' left of centerline, 52' AGL/890' MSL.

Trees beginning 1287' from DER, 524' left of centerline, up to 58' AGL/897' MSL.

Trees beginning 1367' from DER, 476' left of centerline, up to 61' AGL/898' MSL.

Trees beginning 1472' from DER, 72' right of centerline, up to 77' AGL/928' MSL.

Trees beginning 1529' from DER, 176' left of centerline, up to 66' AGL/908' MSL.

Trees beginning 1701' from DER, 824' right of centerline, up to 91' AGL/944' MSL.

Trees beginning 2231' from DER, 841' right of centerline, up to 99' AGL/949' MSL.

Tree 2497' from DER, 969' left of centerline, 69' AGL/913' MSL.

Transmission line 4888' from DER, 1104' left of centerline, 167' AGL/1012' MSL.

Transmission line 5638' from DER, 106' left of centerline, 173' AGL/1018' MSL.

Tower 5639' from DER, 106' left of centerline, 172' AGL/1020' MSL.

Catenary 5730' from DER, 3' right of centerline, 169' AGL/1014' MSL.

**Rwy 18**, terrain 6' from DER, 193' left of centerline, 837' MSL.

Poles beginning 712' from DER, 360' left of centerline, up to 47' AGL/880' MSL.

Poles, tree beginning 744' from DER, 150' right of centerline, up to 33' AGL/866' MSL.

Trees beginning 832' from DER, 572' left of centerline, up to 63' AGL/896' MSL.

Trees beginning 932' from DER, 17' left of centerline, up to 75' AGL/905' MSL.

Trees beginning 1041' from DER, 172' right of centerline, up to 40' AGL/870' MSL.

Trees beginning 1267' from DER, 115' right of centerline, up to 86' AGL/905' MSL.

Trees beginning 1846' from DER, 305' right of centerline, up to 103' AGL/917' MSL.

**Rwy 27**, tree 1341' from DER, 650' right of centerline, 41' AGL/872' MSL.

Pole 1715' from DER, 387' left of centerline, 60' AGL/883' MSL.

Pole 1717' from DER, 462' right of centerline, 57' AGL/884' MSL.

**Rwy 36**, building 199' from DER, 528' left of centerline, 15' AGL/849' MSL.

Pole 313' from DER, 537' left of centerline, 43' AGL/877' MSL.

Tree 366' from DER, 520' left of centerline, 59' AGL/893' MSL.

Trees, poles, vehicle on road beginning 448' from DER, 237' left of centerline, up to 77' AGL/910' MSL.

Pole, vehicle on road beginning 483' from DER, 5' right of centerline, up to 27' AGL/864' MSL.

Pole 524' from DER, 544' right of centerline, 29' AGL/866' MSL.

Tree 560' from DER, 507' right of centerline, 51' AGL/887' MSL.

Trees, buildings, pole beginning 568' from DER, 404' right of centerline, up to 56' AGL/891' MSL.

Trees beginning 1666' from DER, 643' right of centerline, up to 87' AGL/916' MSL.

Trees beginning 1766' from DER, 519' right of centerline, up to 91' AGL/919' MSL.

Trees beginning 1783' from DER, 357' left of centerline, up to 105' AGL/928' MSL.

Trees beginning 1952' from DER, 380' left of centerline, up to 108' AGL/929' MSL.

Trees beginning 2148' from DER, on centerline, up to 109' AGL/932' MSL.

Trees beginning 2740' from DER, 183' right of centerline, up to 103' AGL/925' MSL.

Trees beginning 2857' from DER, 165' right of centerline, up to 125' AGL/945' MSL.

Trees beginning 3244' from DER, 148' left of centerline, up to 106' AGL/934' MSL.

Trees beginning 3309' from DER, 11' left of centerline, up to 107' AGL/936' MSL.

**WASHINGTON, IN****DAVISS COUNTY (DCY)****TAKEOFF MINIMUMS AND (OBSTACLE) DEPARTURE PROCEDURES**

AMDT 1 10AUG23 (23222) (FAA)

**TAKEOFF MINIMUMS:**

**Rwys 9, 27**, NA-Environmental.

**Rwy 18**, 300-2 or std w/min climb of 295'/NM to 700.

**TAKEOFF OBSTACLE NOTES:**

**Rwy 18**, vegetation beginning 7' from DER, 158' left of centerline, up to 5' AGL/471' MSL.

Vegetation beginning 20' from DER, 135' left of centerline, up to 7' AGL/472' MSL.

Terrain 34' from DER, 391' right of centerline, 468' MSL.

NAVAID, terrain beginning 39' from DER, 113' right of centerline, up to 2' AGL/469' MSL.

Tree, vegetation beginning 66' from DER, 95' left of centerline, up to 473' MSL.

Vegetation 83' from DER, 99' left of centerline, 9' AGL/474' MSL.

Vehicles on road beginning 148' from DER, 511' right of centerline, up to 485' MSL.

Vehicles on road beginning 574' from DER, 496' right of centerline, up to 486' MSL.

Trees beginning 1037' from DER, 246' left of centerline, up to 526' MSL.

Tree 1526' from DER, 152' left of centerline, 542' MSL.

Tree 1957' from DER, 223' right of centerline, 538' MSL.

CON'T

**TAKEOFF MINIMUMS, (OBSTACLE) DEPARTURE PROCEDURES, AND  
DIVERSE VECTOR AREA (RADAR VECTORS)**

24025

# TAKEOFF MINIMUMS, (OBSTACLE) DEPARTURE PROCEDURES, AND DIVERSE VECTOR AREA (RADAR VECTORS)

24025

## WASHINGTON, IN (CON'T)

### DAVISS COUNTY (DCY) (CON'T)

**Rwy 18 (CON'T)**, trees beginning 2629' from DER, 265' right of centerline, up to 575' MSL.  
Silo 4155' from DER, 126' left of centerline, 110' AGL/611' MSL.  
Silo, tanks, elevator beginning 4156' from DER, 17' left of centerline, up to 115' AGL/615' MSL.  
Elevator 4221' from DER, 9' left of centerline, 121' AGL/621' MSL.  
Tree 1.5 nm from DER, 2975' right of centerline, 710' MSL.  
**Rwy 36**, poles beginning 651' from DER, 373' right of centerline, up to 482' MSL.  
Tree 2749' from DER, 1110' left of centerline, 545' MSL.  
Trees beginning 2813' from DER, 1113' left of centerline, up to 552' MSL.  
Trees beginning 2926' from DER, 1148' left of centerline, up to 562' MSL.  
Trees beginning 3051' from DER, 880' left of centerline, up to 563' MSL.  
Trees beginning 3430' from DER, 1' left of centerline, up to 569' MSL.  
Tree 3833' from DER, 17' right of centerline, 554' MSL.  
Tree 4069' from DER, 75' right of centerline, 559' MSL.

## WASHINGTON COURT HOUSE, OH

### FAYETTE COUNTY (I23)

#### TAKEOFF MINIMUMS AND (OBSTACLE) DEPARTURE PROCEDURES

AMDT 2 20DEC07 (07354) (FAA)

##### TAKEOFF MINIMUMS:

**Rwy 5**, 300-1<sup>4</sup> or std. w/ min. climb of 268' per NM to 1400.

##### TAKEOFF OBSTACLE NOTES:

**Rwy 5**, train on railroad tracks 384' from DER, 243' right of centerline, 23' AGL/997' MSL.  
Terrain 81' from DER, 184' left of centerline, 0' AGL/978' MSL.  
Silo 8848' from DER, 772' right of centerline, 238' AGL/1213' MSL.  
**Rwy 23**, train on railroad tracks 509' from DER, 257' left of centerline, 23' AGL/1003' MSL.

## WAUSEON, OH

### FULTON COUNTY (USE)

#### TAKEOFF MINIMUMS AND (OBSTACLE) DEPARTURE PROCEDURES

AMDT 1A 17AUG17 (17229) (FAA)

##### TAKEOFF MINIMUMS:

**Rwys 18, 36**, NA - Environmental.

**Rwys 9, 27**, 300-1.

##### TAKEOFF OBSTACLE NOTES:

**Rwy 9**, antenna, building beginning 1137' from DER, 637' left of centerline, up to 808' MSL.  
Trees beginning 1309' from DER, 414' right of centerline, up to 840' MSL.  
Trees beginning 1371' from DER, 562' right of centerline, up to 80' AGL/848' MSL.  
Tree 1455' from DER, 543' right of centerline, 83' AGL/850' MSL.  
Trees beginning 1569' from DER, 635' right of centerline, up to 90' AGL/854' MSL.  
Trees beginning 2161' from DER, 4' left of centerline, up to 111' AGL/876' MSL.  
**Rwy 27**, building 11' from DER, 460' left of centerline, 799' MSL.  
Pole 26' from DER, 487' left of centerline, 808' MSL.  
Antenna, building, road, tree, flagpole, tk, pole beginning 88' from DER, 47' left of centerline, up to 45' AGL/824' MSL.  
Trees beginning 3976' from DER, 170' left of centerline, up to 889' MSL.

## WAVERLY, OH

### PIKE COUNTY (EOP)

#### TAKEOFF MINIMUMS AND (OBSTACLE) DEPARTURE PROCEDURES

AMDT 1 05FEB15 (15036) (FAA)

##### TAKEOFF OBSTACLE NOTES:

**Rwy 7**, REILs 39' from DER, 78' left and 75' right of centerline, 2' AGL/663' MSL.  
Fence at DER, 434' right of centerline, 6' AGL/668' MSL.  
Fence beginning 88' from DER, 462' left of centerline, 9' AGL/671' MSL.  
Buildings beginning 602' from DER, 437' right of centerline, up to 21' AGL/680' MSL.  
Trees beginning 237' from DER, 162' left of centerline, up to 100' AGL/752' MSL.  
Trees beginning 95' from DER, 286' right of centerline, up to 100' AGL/736' MSL.  
**Rwy 25**, REILs 40' from DER, 79' left and 78' right of centerline, 2' AGL/662' MSL.  
Antenna, poles, and vehicle on road beginning 55' from DER, 223' left of centerline, up to 46' AGL/705' MSL.  
Trees, poles, fence, and vehicle on road beginning 79' from DER, 200' right of centerline, up to 100' AGL/739' MSL.  
Vehicles on road beginning 487' from DER, crossing centerline, up to 15' AGL/674' MSL.  
Trees beginning 666' from DER, 444' right of centerline, up to 100' AGL/726' MSL.  
Trees beginning 596' from DER, 267' left of centerline, up to 100' AGL/728' MSL.  
Trees beginning 1422' from DER, crossing centerline, up to 115' AGL/769' MSL.

# TAKEOFF MINIMUMS, (OBSTACLE) DEPARTURE PROCEDURES, AND DIVERSE VECTOR AREA (RADAR VECTORS)

24025

EC-2

# TAKEOFF MINIMUMS, (OBSTACLE) DEPARTURE PROCEDURES, AND DIVERSE VECTOR AREA (RADAR VECTORS)

24025

## WEST UNION, OH

### ALEXANDER SALAMON (AMT)

TAKEOFF MINIMUMS AND (OBSTACLE) DEPARTURE PROCEDURES

AMDT 1 13DEC90 (90347) (FAA)

TAKEOFF MINIMUMS:

**Rwys 5, 23**, 300-1.

DEPARTURE PROCEDURE:

**Rwys 5, 23**, climb straight ahead to 1700 before turning west.

## WILLARD, OH

### WILLARD (8G1)

TAKEOFF MINIMUMS AND (OBSTACLE) DEPARTURE PROCEDURES

AMDT 2 13SEP18 (18256) (FAA)

DEPARTURE PROCEDURE:

**Rwy 10**, climb on heading 103° to 1400 before turning left.

TAKEOFF OBSTACLE NOTES :

**Rwy 10**, building 705' from DER, 149' left of centerline, 19' AGL/959' MSL.

Transmission line 783' from DER, 289' left of centerline, 39' AGL/980' MSL.

Pole 1900' from DER, 418' left of centerline, 32' AGL/985' MSL.

Pole 1965' from DER, 985' left of centerline, 32' AGL/986' MSL.

**Rwy 28**, building beginning 6' from DER, 159' right of centerline, up to 30' AGL/969' MSL.

Pole 78' from DER, 306' left of centerline, up to 30' AGL/969' MSL.

Pole 125' from DER, 326' right of centerline, up to 40' AGL/979' MSL.

Trees beginning 201' from DER, 279' right of centerline, up to 100' AGL/1039' MSL.

Trees beginning 406' from DER, 487' right of centerline, up to 100' AGL/1049' MSL.

Trees beginning 1239' from DER, 144' left of centerline, up to 100' AGL/1069' MSL.

Trees beginning 1300' from DER, 4' right of centerline, up to 100' AGL/1069' MSL.

## WILLOUGHBY, OH

### LAKE COUNTY EXEC (LNN)

TAKEOFF MINIMUMS AND (OBSTACLE) DEPARTURE PROCEDURES

AMDT 3B 26MAR20 (22083) (FAA)

DEPARTURE PROCEDURE:

**Rwy 10**, climb on heading 099° to 1600 before turning right.**Rwy 23**, climb on heading 233° to 1400 before turning right.**Rwy 28**, climb on heading 279° to 1400 before turning left.

TAKEOFF OBSTACLE NOTES:

**Rwy 5**, fence, tree beginning 3' from DER, 273' left of centerline, up to 13' AGL/633' MSL.

Terrain 40' from DER, 382' right of centerline, 625' MSL.

Tree, pole beginning 50' from DER, 343' right of centerline, up to 56' AGL/673' MSL.

Tree 403' from DER, 584' right of centerline, 62' AGL/679' MSL.

Trees beginning 416' from DER, 351' left of centerline, up to 24' AGL/640' MSL.

Tree, building beginning 428' from DER, 538' right of centerline, up to 62' AGL/680' MSL.

Tree, building, fence, electrical system beginning 455' from DER, 244' right of centerline, up to 703' MSL.

Trees beginning 522' from DER, 466' left of centerline, up to 660' MSL.

Trees beginning 662' from DER, 587' left of centerline, up to 62' AGL/674' MSL.

Tree 802' from DER, 558' left of centerline, 76' AGL/688' MSL.

Trees beginning 811' from DER, 528' left of centerline, up to 101' AGL/714' MSL.

Trees beginning 1070' from DER, 15' left of centerline, up to 109' AGL/728' MSL.

Tree, electrical system beginning 1286' from DER, 168' right of centerline, up to 98' AGL/716' MSL.

Trees beginning 1994' from DER, 356' right of centerline, up to 101' AGL/720' MSL.

Tree, electrical system beginning 2034' from DER, 434' right of centerline, up to 725' MSL.

Tree, electrical system, pole, transmission line beginning 2120' from DER, 10' right of centerline, up to 116' AGL/734' MSL.

Trees beginning 2613' from DER, 31' left of centerline, up to 109' AGL/732' MSL.

Tree 3426' from DER, 525' right of centerline, 107' AGL/736' MSL.

Trees beginning 3427' from DER, 328' right of centerline, up to 119' AGL/737' MSL.

Trees beginning 3667' from DER, 29' right of centerline, up to 124' AGL/740' MSL.

Trees beginning 4179' from DER, 303' left of centerline, up to 737' MSL.

**Rwy 10**, fence 77' from DER, 478' right of centerline, 10' AGL/633' MSL.

Trees beginning 168' from DER, 353' right of centerline, up to 63' AGL/684' MSL.

Tree, building, pole beginning 348' from DER, 139' right of centerline, up to 76' AGL/698' MSL.

Pole, tree beginning 405' from DER, 142' left of centerline, up to 34' AGL/656' MSL.

Tree, building, electrical system, transmission line, pole, vertical point beginning 437' from DER, 3' right of centerline, up to 95' AGL/717' MSL.

Electrical system, vertical point, transmission line, pole, lighting beginning 607' from DER, 26' left of centerline, up to 55' AGL/677' MSL.

Electrical system, tree, pole beginning 694' from DER, 54' left of centerline, up to 60' AGL/682' MSL.

Tree, electrical system, building beginning 733' from DER, 66' left of centerline, up to 67' AGL/695' MSL.

Tree, electrical system beginning 773' from DER, 10' left of centerline, up to 78' AGL/701' MSL.

Tree, building beginning 850' from DER, 520' left of centerline, up to 86' AGL/709' MSL.

Tree, electrical system beginning 955' from DER, 78' left of centerline, up to 89' AGL/711' MSL.

Tree, electrical system beginning 1081' from DER, 142' right of centerline, up to 98' AGL/721' MSL.

Tree, electrical system beginning 1112' from DER, 83' left of centerline, up to 105' AGL/727' MSL.

CONT

# TAKEOFF MINIMUMS, (OBSTACLE) DEPARTURE PROCEDURES, AND DIVERSE VECTOR AREA (RADAR VECTORS)

24025

# TAKEOFF MINIMUMS, (OBSTACLE) DEPARTURE PROCEDURES, AND DIVERSE VECTOR AREA (RADAR VECTORS)

24025

## WILLOUGHBY, OH (CON'T) LAKE COUNTY EXEC (LNN) (CON'T)

**Rwy 10 (CON'T)**, trees beginning 1226' from DER, 4' right of centerline, up to 730' MSL.  
Trees beginning 1260' from DER, 1' right of centerline, up to 108' AGL/732' MSL.  
Trees beginning 2218' from DER, 4' left of centerline, up to 112' AGL/733' MSL.  
Trees beginning 2349' from DER, 85' right of centerline, up to 112' AGL/736' MSL.  
Trees beginning 2428' from DER, 15' right of centerline, up to 116' AGL/742' MSL.  
Trees beginning 3541' from DER, 187' left of centerline, up to 110' AGL/736' MSL.

**Rwy 23**, fence 4' from DER, 489' left of centerline, 8' AGL/633' MSL.  
Tree, fence, electrical system, building beginning 94' from DER, 62' left of centerline, up to 687' MSL.  
Building 195' from DER, 495' right of centerline, 29' AGL/652' MSL.  
Building, fence, electrical system, pole beginning 200' from DER, 448' right of centerline, up to 49' AGL/672' MSL.  
Tree 526' from DER, 591' right of centerline, 77' AGL/698' MSL.

Tree, transmission line, pole, electrical system beginning 529' from DER, 363' right of centerline, up to 79' AGL/701' MSL.  
Tree, pole, transmission line, electrical system beginning 628' from DER, 166' right of centerline, up to 87' AGL/709' MSL.  
Trees beginning 1582' from DER, 204' left of centerline, up to 78' AGL/701' MSL.  
Trees beginning 1659' from DER, 119' left of centerline, up to 714' MSL.  
Trees beginning 1971' from DER, 260' right of centerline, up to 722' MSL.  
Trees beginning 1987' from DER, 22' right of centerline, up to 100' AGL/724' MSL.  
Tree 3023' from DER, 52' left of centerline, 94' AGL/717' MSL.  
Trees beginning 3037' from DER, 269' left of centerline, up to 111' AGL/721' MSL.  
Trees beginning 3445' from DER, 327' right of centerline, up to 105' AGL/728' MSL.  
Trees beginning 3792' from DER, 1078' right of centerline, up to 108' AGL/730' MSL.

**Rwy 28**, antenna 579' from DER, 325' right of centerline, 20' AGL/640' MSL.  
Building 835' from DER, 209' left of centerline, 23' AGL/645' MSL.  
Building 845' from DER, 561' left of centerline, 29' AGL/652' MSL.  
Building, electrical system, pole beginning 876' from DER, 410' left of centerline, up to 49' AGL/672' MSL.  
Electrical system 965' from DER, 470' right of centerline, 34' AGL/653' MSL.  
Electrical system, transmission line, pole, building beginning 985' from DER, 338' right of centerline, up to 44' AGL/661' MSL.  
Tree 1134' from DER, 436' left of centerline, 77' AGL/698' MSL.  
Tree 1140' from DER, 188' right of centerline, 45' AGL/664' MSL.  
Trees beginning 1141' from DER, 397' left of centerline, up to 706' MSL.  
Trees beginning 1143' from DER, 541' right of centerline, up to 692' MSL.  
Trees beginning 1186' from DER, 386' right of centerline, up to 74' AGL/694' MSL.  
Trees beginning 1213' from DER, 8' left of centerline, up to 87' AGL/709' MSL.  
Tree 1240' from DER, 378' right of centerline, 76' AGL/695' MSL.  
Trees beginning 1278' from DER, 21' right of centerline, up to 700' MSL.  
Trees beginning 1711' from DER, 21' right of centerline, up to 95' AGL/711' MSL.  
Tree 2447' from DER, 207' left of centerline, 99' AGL/715' MSL.  
Trees beginning 2467' from DER, 200' left of centerline, up to 102' AGL/723' MSL.  
Trees beginning 2671' from DER, 172' left of centerline, up to 108' AGL/728' MSL.  
Tree 3022' from DER, 121' left of centerline, 116' AGL/735' MSL.  
Tree, antenna beginning 3105' from DER, 248' left of centerline, up to 123' AGL/743' MSL.

## WILMINGTON, OH CLINTON FLD (I66)

TAKEOFF MINIMUMS AND (OBSTACLE) DEPARTURE PROCEDURES  
AMDT 2 05JUL07 (21224) (FAA)

### TAKEOFF MINIMUMS:

**Rwy 3**, 300-1¼ or std. w/min. climb of 224' per NM to 1300', or alternatively, with std. takeoff minimums and a normal 200'/NM climb gradient, takeoff must occur no later than 1700' prior to DER.

### TAKEOFF OBSTACLE NOTES:

**Rwy 3**, multiple trees beginning 76' from DER, 76' right of centerline, up to 88' AGL/1137' MSL.

Multiple trees beginning 279' from DER, 140' left of centerline, up to 96' AGL/1105' MSL.

Water tank 1 NM from DER, 554' left of centerline, 176' AGL/1205' MSL.

**Rwy 21**, multiple trees beginning 187' from DER, 509' right of centerline, up to 87' AGL/1111' MSL.

Multiple trees beginning 243' from DER, 214' left of centerline, up to 77' AGL/1086' MSL.

## WILMINGTON AIR PARK (ILN)

TAKEOFF MINIMUMS AND (OBSTACLE) DEPARTURE PROCEDURES  
ORIG 27AUG09 (09239) (FAA)

### TAKEOFF OBSTACLE NOTES:

**Rwy 4L**, tree 1032' from DER, 644' right of centerline, 35' AGL/1114' MSL.

**Rwy 22L**, tree 2437' from DER, 468' left of centerline, 100' AGL/1134' MSL.

# TAKEOFF MINIMUMS, (OBSTACLE) DEPARTURE PROCEDURES, AND DIVERSE VECTOR AREA (RADAR VECTORS)

24025



# TAKEOFF MINIMUMS, (OBSTACLE) DEPARTURE PROCEDURES, AND DIVERSE VECTOR AREA (RADAR VECTORS)

24025

## WINAMAC, IN

### ARENS FLD (RWN)

#### TAKEOFF MINIMUMS AND (OBSTACLE) DEPARTURE PROCEDURES

ORIG-A 11OCT18 (21224) (FAA)

#### TAKEOFF MINIMUMS:

**Rwy 9**, 300-1½ or std. w/min. climb of 225' per NM to 1000

#### TAKEOFF OBSTACLE NOTES:

**Rwy 9**, fence 195' from DER, 190' right of centerline, 5' AGL/712' MSL.

Pole, NAVAID and vehicle beginning 268' from DER, 21' left of centerline, up to 26' AGL/735' MSL.

Tree 356' from DER, 172' right of centerline, 723' MSL.

Pole 595' from DER, 409' right of centerline, 34' AGL/741' MSL.

Pole 729' from DER, 393' left of centerline, 31' AGL/740' MSL.

Poles beginning 736' from DER, 172' right of centerline, up to 37' AGL/745' MSL.

Tree 2466' from DER, 463' left of centerline, 782' MSL.

Tower 1 NM from DER, 24' left of centerline, 181' AGL/894' MSL.

**Rwy 27**, fence 6' from DER, 203' left of centerline, 2' AGL/707' MSL.

Tree 99' from DER, 190' left of centerline, 715' MSL.

Fence 108' from DER, 208' right of centerline, 3' AGL/709' MSL.

Tree 1660' from DER, 852' right of centerline, 757' MSL.

## WINCHESTER, IN

### RANDOLPH COUNTY (I22)

#### TAKEOFF MINIMUMS AND (OBSTACLE) DEPARTURE PROCEDURES

ORIG 10MAR11 (11069) (FAA)

#### TAKEOFF OBSTACLE NOTES:

**Rwy 8**, power poles beginning 503' from DER, 433' right of centerline, up to 26' AGL/1155' MSL.

Trees 1013' from DER, 586' right of centerline, 38' AGL/1167' MSL.

Trees beginning 3523' from DER, 112' right of centerline, up to 101' AGL/1220' MSL.

Tree 1745' from DER, 718' left of centerline, 61' AGL/1180' MSL.

**Rwy 26**, trees and power pole beginning 389' from DER, 461' right of centerline, up to 59' AGL/1178' MSL.

Barn and silo beginning 590' from DER, 360' right of centerline, up to 32' AGL/1151' MSL.

Tree 479' from DER, 571' left of centerline, 23' AGL/ 1142' MSL.

Power poles, antenna, and barn beginning 913' from DER, 444' left of centerline, up to 34' AGL/ 1153' MSL.

Tree and antenna beginning 1023' from DER, 424' left of centerline, up to 43' AGL/1162' MSL.

## WOODSFIELD, OH

### MONROE COUNTY (4G5)

#### TAKEOFF MINIMUMS AND (OBSTACLE) DEPARTURE PROCEDURES

AMDT 2 30MAY91 (91150) (FAA)

#### TAKEOFF MINIMUMS:

**Rwy 25**, 300-1.

## WOOSTER, OH

### WAYNE COUNTY (BJJ)

#### TAKEOFF MINIMUMS AND (OBSTACLE) DEPARTURE PROCEDURES

AMDT 1A 26APR18 (18116) (FAA)

#### TAKEOFF MINIMUMS:

**Rwy 28**, 300-1.

#### TAKEOFF OBSTACLE NOTES :

**Rwy 10**, traverse way 11' from DER, 479' right of centerline, 1141' MSL.

Traverse way beginning 61' from DER, 359' left of centerline, up to 1143' MSL.

Pole, traverse way beginning 126' from DER, 40' right of centerline, up to 34' AGL/1159' MSL.

Pole, traverse way beginning 165' from DER, 69' left of centerline, up to 33' AGL/1157' MSL.

**Rwy 28**, vegetation 44' from DER, 467' right of centerline, 5' AGL/1116' MSL.

Trees, beginning 1243' from DER, 400' left of centerline, up to 1240' MSL.

Trees, beginning 2584' from DER, 229' right of centerline, up to 1203' MSL.

22 FEB 2024 to 21 MAR 2024

22 FEB 2024 to 21 MAR 2024

# TAKEOFF MINIMUMS, (OBSTACLE) DEPARTURE PROCEDURES, AND DIVERSE VECTOR AREA (RADAR VECTORS)

24025

EC-2

# TAKEOFF MINIMUMS, (OBSTACLE) DEPARTURE PROCEDURES, AND DIVERSE VECTOR AREA (RADAR VECTORS)

24025

## WRIGHT-PATTERSON AFB (KFFO)

DAYTON, OH

TAKEOFF MINIMUMS AND (OBSTACLE) DEPARTURE PROCEDURES

22OCT09 (09295)

TAKEOFF MINIMUMS:

**Rwy 5R, 200-1½\*****Rwy 23R, 400-2¼\*\*****Rwy 23L, 400-2¼\*\*\***

\* Or std. w/min. climb of 240ft/NM to 1100'.

\*\* Or std. w/min. climb of 260ft/NM to 1300'.

\*\*\* Or std. w/min. climb of 210ft/NM to 1300'.

**Rwy 5R**, climb on track 050° until reaching 1100.

TAKEOFF OBSTACLE NOTES:

**Rwy 23L:** 43' AGL VORTAC, 850' from DER, 662' right of centerline.**Rwy 5L:** Up to 105' AGL tree line beginning 3000' from DER, 700' right of centerline to 5100' from DER, 1300' left of centerline.

## YOUNGSTOWN, OH

YOUNGSTOWN ELSER METRO (4G4)

TAKEOFF MINIMUMS AND (OBSTACLE) DEPARTURE PROCEDURES

AMDT 1A 05FEB15 (15036) (FAA)

TAKEOFF MINIMUMS:

**Rwy 10**, 300-1¼ or std. w/min. climb of 237' per NM to 1500.**Rwy 28**, 300-2¼ or std. w/min. climb of 463' per NM to 1300.

DEPARTURE PROCEDURE:

**Rwy 10**, climb heading 098° to 2000 before proceeding on course.**Rwy 28**, climb heading 278° to 1700 before turning right.

TAKEOFF OBSTACLE NOTES:

**Rwy 10**, vehicle on road 200' from DER, on centerline, 15' AGL/1104' MSL.

Hangar and trees beginning 34' from DER, 203' right of centerline, up to 100' AGL/1189' MSL.

Trees and tower beginning 283' from DER, 322' left of centerline, up to 138' AGL/1332' MSL.

**Rwy 28**, trees on centerline, beginning 3380' from DER, up to 100' AGL/1209' MSL.

Trees beginning at DER, 222' right of centerline, up to 100' AGL/1119' MSL.

Trees beginning at DER, 191' left of centerline, up to 100' AGL/1119' MSL.

## YOUNGSTOWN/WARREN, OH

YOUNGSTOWN/WARREN RGNL (YNG)

TAKEOFF MINIMUMS AND (OBSTACLE) DEPARTURE PROCEDURES

AMDT 4 26JUL90 (21336) (FAA)

TAKEOFF MINIMUMS:

**Rwy 23**, 300-1.

## ZANESVILLE, OH

ZANESVILLE MUNI (ZZV)

TAKEOFF MINIMUMS AND (OBSTACLE) DEPARTURE PROCEDURES

AMDT 1 27JAN22 (22027) (FAA)

TAKEOFF MINIMUMS:

**Rwy 16**, 300-1¼ or std. w/min. climb of 215' per NM to 1200, or alternatively, with std. takeoff minimums and a normal 200' per NM climb gradient, takeoff must occur no later than 1400' prior to DER.

TAKEOFF OBSTACLE NOTES:

**Rwy 4**, trees, lighting, NAVAID beginning 45' from DER, 115' right of centerline, up to 92' AGL/900' MSL.

Lighting, NAVAID beginning 51' from DER, 114' left of centerline, up to 3' AGL/873' MSL.

Fence 80' from DER, 506' left of centerline, 874' MSL.

Tree 534' from DER, 634' left of centerline, 907' MSL.

**Rwy 16**, tree, vegetation beginning 2' from DER, 66' right of centerline, up to 929' MSL.

Vegetation 105' from DER, 95' left of centerline, 7' AGL/899' MSL.

Tree 194' from DER, 386' right of centerline, 939' MSL.

Trees beginning 208' from DER, 61' right of centerline, up to 99' AGL/956' MSL.

Trees beginning 1280' from DER, 331' left of centerline, up to 934' MSL.

Trees beginning 1435' from DER, 62' right of centerline, up to 958' MSL.

Tree 1438' from DER, 528' left of centerline, 939' MSL.

Trees beginning 1465' from DER, 35' right of centerline, up to 962' MSL.

Trees beginning 1522' from DER, 28' left of centerline, up to 942' MSL.

Tree 1618' from DER, 446' left of centerline, 944' MSL.

Trees beginning 1730' from DER, 378' left of centerline, up to 945' MSL.

Trees beginning 1860' from DER, 58' right of centerline, up to 968' MSL.

Trees beginning 1955' from DER, 96' left of centerline, up to 74' AGL/947' MSL.

Trees beginning 1977' from DER, 5' right of centerline, up to 972' MSL.

Trees beginning 2099' from DER, 129' left of centerline, up to 62' AGL/948' MSL.

Trees beginning 2107' from DER, 8' left of centerline, up to 74' AGL/956' MSL.

Trees beginning 2127' from DER, 5' right of centerline, up to 980' MSL.

Trees beginning 2134' from DER, 46' left of centerline, up to 74' AGL/961' MSL.

CONT

# TAKEOFF MINIMUMS, (OBSTACLE) DEPARTURE PROCEDURES, AND DIVERSE VECTOR AREA (RADAR VECTORS)

24025

**TAKEOFF MINIMUMS, (OBSTACLE) DEPARTURE PROCEDURES, AND**

  
**DIVERSE VECTOR AREA (RADAR VECTORS)**

24025

**ZANESVILLE, OH (CON'T)****ZANESVILLE MUNI (ZZV) (CON'T)****Rwy 16 (CON'T)**, trees beginning 2241' from DER, 6' left of centerline, up to 75' AGL/971' MSL.

Trees beginning 2276' from DER, 17' left of centerline, up to 77' AGL/975' MSL.

Trees beginning 5615' from DER, 1532' right of centerline, up to 1041' MSL.

Tree 1 NM from DER, 615' right of centerline, 102' AGL/1065' MSL.

**Rwy 22**, vehicle on road, NAVAID, tree beginning 2' from DER, 114' right of centerline, up to 910' MSL.

Tree, NAVAID beginning 28' from DER, 114' left of centerline, up to 904' MSL.

Tree 105' from DER, 185' left of centerline, 25' AGL/917' MSL.

Trees beginning 305' from DER, 293' left of centerline, up to 975' MSL.

Trees beginning 419' from DER, 291' left of centerline, up to 984' MSL.

Tree 1285' from DER, 565' right of centerline, 932' MSL.

**Rwy 34**, trees, vegetation beginning 23' from DER, 54' left of centerline, up to 78' AGL/920' MSL.

Trees beginning 71' from DER, 212' right of centerline, up to 888' MSL.

Trees beginning 472' from DER, 268' right of centerline, up to 894' MSL.

Tree 1348' from DER, 189' right of centerline, 75' AGL/903' MSL.

Tree 1351' from DER, 211' right of centerline, 73' AGL/904' MSL.

Tree 1365' from DER, 216' right of centerline, 73' AGL/906' MSL.

Trees beginning 1365' from DER, 144' right of centerline, up to 84' AGL/912' MSL.

Trees beginning 1412' from DER, 112' right of centerline, up to 78' AGL/915' MSL.

Trees beginning 1437' from DER, 67' right of centerline, up to 77' AGL/920' MSL.

Tree 1521' from DER, 277' left of centerline, 101' AGL/921' MSL.

Tree 1525' from DER, 299' left of centerline, 100' AGL/923' MSL.

Trees beginning 1531' from DER, 4' right of centerline, up to 926' MSL.

Tree 1563' from DER, 386' left of centerline, 934' MSL.

Trees beginning 1567' from DER, 28' left of centerline, up to 936' MSL.

Trees beginning 1674' from DER, 34' right of centerline, up to 933' MSL.

Trees beginning 1680' from DER, 3' left of centerline, up to 937' MSL.

Trees beginning 1688' from DER, 15' right of centerline, up to 943' MSL.

Trees beginning 1805' from DER, 1' left of centerline, up to 941' MSL.

Trees, building beginning 1878' from DER, 6' right of centerline, up to 952' MSL.

Trees beginning 1880' from DER, 10' left of centerline, up to 946' MSL.

Trees beginning 1976' from DER, 16' left of centerline, up to 95' AGL/956' MSL.

Trees beginning 2322' from DER, 137' left of centerline, up to 962' MSL.

Trees beginning 2420' from DER, 119' left of centerline, up to 968' MSL.

Grain elevator, building beginning 2977' from DER, 73' right of centerline, up to 65' AGL/954' MSL.

Trees beginning 3046' from DER, 17' left of centerline, up to 975' MSL.

Tree 3581' from DER, 80' right of centerline, 75' AGL/957' MSL.

Tree 3592' from DER, 97' right of centerline, 78' AGL/959' MSL.

Trees beginning 3593' from DER, 7' right of centerline, up to 93' AGL/968' MSL.

22 FEB 2024 to 21 MAR 2024

22 FEB 2024 to 21 MAR 2024

**TAKEOFF MINIMUMS, (OBSTACLE) DEPARTURE PROCEDURES, AND**

  
**DIVERSE VECTOR AREA (RADAR VECTORS)**

24025